



**CD Automation UK Ltd**

Product Support:

Tel: +44 1323 811100 Email: [info@cdautomation.co.uk](mailto:info@cdautomation.co.uk)





## Declaration of conformity

### Declaration of conformity - Dichiarazione di Conformità

#### PRODUCT MANUFACTURER / PRODUTTORE:



**CD Automation S.R.L.**  
Controllers, Drives & Automation

Via Picasso, 34/36 - 20025 Legnano (MI)- Italy  
P.I. 08925720156 -Tel. +39 0331 577479 - Fax +39 0331 579479  
E-mail: info@cdautomation.com - Web: www.cdautomation.com

#### Declare that the product / Dichiaro che il prodotto:

**CUSTOM 2PH 1100A-1400A-1600A-1800A-2100A**

PRODUCT DESCRIPTION: Electric power control  
SCOPE OF APPLICATION: Thermal control process  
DESCRIZIONE DEL PRODOTTO: Unità di controllo potenza elettrica  
UTILIZZO: Controllo processi termici

#### FULFILLS THE REQUIREMENTS OF THE STANDARD:

|                            |   |
|----------------------------|---|
| Electrical safety Standard | EN60947-1: 2007 + A1 2011, A2 2014<br>EN60947-4-3: 2014 |
| Generic Emission standard  | EN60947-4-3: 2014 Group 1 Class A emissions             |
| Generic Immunity standard  | EN60947-4-3: 2014 Industrial Immunity                   |

#### SODDISFA I REQUISITI DELLA NORMA:

|                           |   |
|---------------------------|---|
| Specifica di sicurezza    | EN60947-1: 2007 + A1 2011, A2 2014<br>EN60947-4-3: 2014 |
| Specifica sulle emissioni | EN60947-4-3: 2014 gruppo 1 emissioni classe A           |
| Specifica sulle Immunità  | EN60947-4-3: 2014 Immunità industriale                  |

CDAutomation declares that the products above mentioned are conforming to the directive  
CDAutomation dichiara che i prodotti sopra menzionati sono conformi alla direttiva  
Bassa Tensione (low Voltage) **EMC directive updated 2014/30/EU,**  
**Low Voltage Directive updated 2014/35/EU**

Issued on: 20/03/2017  
Data di emissione: 20/03/2017

Amministratore Unico e  
Legale Rappresentante







Claudio Brizzi

# Important warnings for safety

This chapter contains important information for the safety. The not observance of these instructions may result in serious personal injury or death and can cause serious damages to the Thyristor unit and to the components system included.

*The installation should be performed by qualified persons.*

In the manual are used symbols to give more evidence at the notes of safety and operativity for the attention for the user:

|   |  |
|---|--|
|    | This icon is present in all the operational procedures where the Improper operation may result in serious personal injury or death by Electrical Shock Hazard Symbol (a lightning bolt in a triangle) precedes an electric shock hazard CAUTION or WARNING safety statement. |
|    | Warning or Hazard that needs further explanation than the label on unit can provide. Consult User's Guide for further information.   |
|    | Unit is compliant with European Union directives. See Declaration of Conformity for further details on Directives and Standards used for Compliance.   |
|   | If available, unit is a Listed device per Underwriters Laboratories. It has been investigated to ANSI/UL® 508 standards for Industrial Control Switches and equivalent to CSA C22.2 #14. For more detail search for File E231578 on www.ul.com                               |
|  | ESD Sensitive product, use proper grounding and handling techniques when installing or servicing product.  |
|  | Do not throw in trash, use proper recycling techniques or consult manufacturer for proper disposal.  |

A **"NOTE"** marks a short message to alert you to an important detail.

A **"CAUTION"** safety alert appears with information that is important for protecting your equipment and performance. Be especially careful to read and follow all cautions that apply to your application.





















A **"WARNING"** safety alert appears with information that is important for protecting you, others and equipment from damage. Pay very close attention to all warnings that apply to your application.

## Safety notes

 **WARNING!** To avoid damage to property and equipment, injury and loss of life, adhere to applicable electrical codes and standard wiring practices when installing and operating this product. Failure to do so could result in damage, injury and death.

 **AVERTISSEMENT!** Pour éviter d'endommager la propriété et l'équipement, les blessures et la perte de vie, respecter les codes électriques en vigueur et les pratiques de câblage standard au moment de l'installation et de l'utilisation de ce produit. Dans le cas contraire, cela peut entraîner la mort, des blessures graves ou des dommages.

-  **WARNING!** All service including inspection, installation, wiring, maintenance, troubleshooting, fuse or other user serviceable component replacement must be performed only by properly qualified personnel. Service personnel must read this manual before proceeding with work. While service is being performed unqualified personnel should not work on the unit or be allowed in the immediate vicinity.
-  **AVERTISSEMENT!** Tous les services, y compris l'inspection, l'installation, le câblage, l'entretien, le dépannage, le remplacement de fusibles ou d'autres composants pouvant être réparés par l'utilisateur, doivent être effectués uniquement par un personnel d'entretien qualifié. Le personnel de service doit lire ce manuel avant d'effectuer tout travail. Pendant que l'entretien est exécuté, tout personnel non qualifié ne doit effectuer de travail sur l'appareil ni se trouver à proximité.
-  **WARNING!** When in use the power controller is connected to dangerous voltages. Do not remove the protective covers without first disconnecting and preventing power from being restored while servicing the unit.
-  **AVERTISSEMENT!** Au moment de l'utilisation, le régulateur de puissance est connecté à des tensions dangereuses. Ne retirer aucun couvercle de protection sans d'abord débrancher l'appareil et ainsi empêcher l'alimentation d'être rétablie pendant l'entretien.
-  **WARNING!** Do not use in aerospace or nuclear applications.
-  **AVERTISSEMENT!** Ne pas utiliser pour les applications aérospatiales ou nucléaires.
-  **WARNING!** The power controller's protection rating is IP20 with all covers installed and closed. It must be installed in an enclosure that provides all the necessary additional protections appropriate for the environment and application.
-  **AVERTISSEMENT!** L'indice de protection du régulateur de puissance est de IP20 lorsque les couvercles sont installés et fermés. L'appareil doit être installé dans une enceinte qui assure toute la protection supplémentaire nécessaire pour l'environnement et l'application.
-  **WARNING!** Ground the power controller via the provided protective earth grounding terminal. Verify ground is within impedance specifications. This should be verified periodically.
-  **AVERTISSEMENT!** Mise à la terre du régulateur de puissance par le biais de la borne de prise de terre de protection fournie. Vérifier que la prise de terre est conforme aux spécifications de l'impédance. Cela doit être vérifié périodiquement.
-  **WARNING!** Electric Shock Hazard: when the power controller has been energized, after shutting off the power, wait at least one minute for internal capacitors to discharge before commencing work that brings you in to contact with power connections or internal components.
-  **AVERTISSEMENT!** Risque de décharges électriques: lorsque le régulateur de puissance est mis sous tension, après avoir été éteint, attendre au moins une minute pour que les condensateurs internes se déchargent avant de commencer tout travail incluant le contact avec les connexions électriques ou les composants internes.
-  **WARNING!** The installation must be protected by electromagnetic circuit breakers or by fuses. The semiconductor fuses located inside the power controller are classified for UL as supplementary protection for semiconductor devices. They are not approved for branch circuit protection.
-  **AVERTISSEMENT!** L'installation doit être protégée par des disjoncteurs électromagnétiques ou des fusibles. Les fusibles pour semi-conducteurs situés à l'intérieur du régulateur de puissance sont classés UL comme protection supplémentaire pour les dispositifs pour semi-conducteurs. Ils ne sont pas approuvés pour la protection des circuits de dérivation.
-  **WARNING!** When making live voltage or current measurements, use proper personal protective equipment for the voltages and arc-flash potentials involved.
-  **AVERTISSEMENT!** Au moment de relever des mesures de tension ou de courant en direct, utiliser un équipement de protection individuelle approprié pour les tensions et les potentiels d'arc électrique concernés.

-  **WARNING!** Verify the voltage and current ratings of the power controller are correct for the application.
-  **AVERTISSEMENT!** Vérifier que les valeurs de tension et de courant du régulateur de puissance sont correctes pour l'application.
-  **CAUTION:** To avoid compromising the insulation, do not bend wire or other components beyond their bend radius specifications.
-  **ATTENTION:** Pour éviter de compromettre l'isolation, ne pas plier le fil ou tout autre composant au-delà de ses spécifications en matière de rayon de courbure.
-  **CAUTION:** Protect the power controller from high temperature, humidity and vibrations.
-  **ATTENTION:** Protéger le régulateur de puissance contre les températures élevées, l'humidité et les vibrations.
-  **CAUTION:** The power controller warranty is void if the tested and approved fuses are not used.
-  **ATTENTION:** La garantie du régulateur de puissance est nulle si aucun fusible testé et approuvé n'est utilisé.
-  **CAUTION:** Only trained and authorized personnel should access and handle the internal electronics and they must follow proper electro-static prevention procedures.
-  **ATTENTION:** Seul le personnel formé et autorisé peut accéder aux composants électroniques internes et les gérer, et il doit se conformer à des procédures de prévention électrostatique appropriées.
-  **CAUTION:** Install an appropriately sized RC filter across contactor coils, relays and other inductive loads.
-  **ATTENTION:** Installer un filtre RC de dimensions appropriées sur les bobines du contacteur, les relais et autres charges par induction.
-  **CAUTION:** The thyristor units here described have been designed for use with sinusoidal networks with nominal frequency 50-60 Hz. Any application with NON-SINUSOIDAL, distorted or disturbed networks could compromise the correct operation of the unit.
-  **ATTENTION:** Les unités de thyristors décrites ici ont été conçues pour être utilisées avec des réseaux sinusoïdaux d'une fréquence nominale de 50 à 60 Hz. Toute application utilisant des réseaux NON SINUSOÏDAUX, déformés ou perturbés peut compromettre le bon fonctionnement de l'appareil.
-  **NOTE:** Provide a local disconnect to isolate the power controller for servicing.
-  **REMARQUE:** Fournir une déconnexion locale afin d'isoler le régulateur de puissance pour l'entretien.
-  **NOTE:** The nominal current is specified for ambient temperatures at or below 40° C. Ensure the application design allows for adequate cooling of each power controller. The power controller must be mounted vertically. The cooling design must prevent air heated by one power controller from causing power controllers mounted above to exceed the ambient operating temperature limit. When power controllers are mounted side by side allow a minimum spacing of 15mm between them.
-  **REMARQUE:** Le courant nominal est précisé pour des températures ambiantes égales ou inférieures à 40°C. S'assurer que la conception de l'application permette le refroidissement adéquat de chaque régulateur de puissance. Le régulateur de puissance doit être monté verticalement. La conception de refroidissement doit empêcher l'air chauffé par le régulateur de puissance de dépasser la limite de température de fonctionnement ambiante de la part des régulateurs de puissance montés au-dessus. Lorsque les régulateurs de puissance sont montés côte à côte, il faut conserver un espacement minimal de 15 mm entre les deux.
-  **NOTE:** Use only copper cables and wires rated for use at 75°C or greater.
-  **REMARQUE:** N'utiliser que des câbles et des fils en cuivre pour l'utilisation à 75°C ou plus.



## Maintenance

In order to have a corrected cooling, the user must clean the heat-sink and the protective grill of the fans. The frequency of this servicing depends on environmental pollution.

Also check periodically if the screw for the power cables and safety earth are tightened correctly (See Connection Diagram)

### Warranty condition

Producer gives a 12 months warranty to its products.

The warranty is limited to repairing and parts substitution in our factory and does exclude products not properly used and fuses.

Warranty does not include products with serial numbers deleted. The faulty product should be shipped to Producer at customer's cost and our Service will evaluate if product is under warranty terms.

Substituted parts remain of Producer property.



## Return Material Authorization (RMA)

Customers wishing to return any items, whether they are incorrectly supplied, faulty or damaged in transit, must first complete a Return Material Authorisation (RMA) form to obtain an RMA number from the Service Department.

A full repair service is available for customers. Prior to submitting the RMA form and returning products, customers are recommended to contact the technical support team to determine whether the issue can be resolved with telephone support.

### How the RMA service works

The RMA form and details are available on our web sites:

<https://www.cdautomation.com/returns-material-authorisation/>

When completing the RMA form, please be as specific as possible about the problem, including any pertinent application details. The more information given, the more quickly and more thoroughly the problem can be solved. The minimum information required is:

1. The Full Model Number
2. Quantity of units being returned
3. The units Serial Number(s)
4. A description of the problem ("faulty" or "unknown" is not sufficient)



# Summary

- Declaration of conformity. . . . . 3
- Important warnings for safety . . . . . 4
- Maintenance . . . . . 7
- 1 Quick Start . . . . . 10
- 2 Basic Connections and sizing . . . . . 11
- 3 Identification and Order Code . . . . . 12
  - 3.1 Identification of the unit . . . . . 12
- 4 Technical Specifications. . . . . 14
  - 4.1 General features . . . . . 14
  - 4.2 Input features . . . . . 14
  - 4.3 Output features 600V . . . . . 14
  - 4.4 Output features 690V . . . . . 14
  - 4.5 Environmental installation conditions . . . . . 15
  - 4.6 Derating Curve and Thermal conditions . . . . . 15
  - 4.7 Calculating flow capacity of the fan. . . . . 15
- 5 Installation . . . . . 16
  - 5.1 Dimensions and Weight. . . . . 16
  - 5.2 Fixing holes . . . . . 17
- 6 Wiring instructions . . . . . 18
  - 6.1 Terminals Positions . . . . . 18
  - 6.2 Power Terminals . . . . . 19
  - 6.3 IP20 Cover OPTION . . . . . 21
  - 6.4 Power cable dimensions (suggested) . . . . . 22
  - 6.5 Cable dimensions (suggested) of Earth and of the Command Terminals . . 22
  - 6.6 Command Terminals . . . . . 23
  - 6.7 Fan Supply For Each Phase (MX1 – MX2) . . . . . 25
  - 6.8 Thermal Switch For Each Phase (MX1 – MX2). . . . . 25
  - 6.9 Schematic . . . . . 26
  - 6.10 Connection Diagram for 3 phases (control on 2 phases) . . . . . 27
- 7 Access to the Electronic Board . . . . . 28



- 8 Supply the Electronic Board . . . . . 29**
  - 8.1 Fuse Board protection . . . . . 30
- 9 Control Input type setting. . . . . 31**
- 10 Input output signal . . . . . 32**
  - 10.1 Digital Input. . . . . 32
  - 10.2 Digital Output . . . . . 32
- 11 Heater Break alarm and SCR short circuit (HB Option) . . . . . 34**
  - 11.1 Heater break Calibration procedure . . . . . 34
  - 11.2 HB alarm contact . . . . . 34
- 12 Control Panel. . . . . 35**
  - 12.1 Scroll the parameters . . . . . 37
  - 12.2 Operator Menu *oPEr* . . . . . 38
  - 12.3 Setup Menu *SEt* . . . . . 38
  - 12.4 Hardware Menu *HU* . . . . . 39
  - 12.5 Displayed Alarms . . . . . 40
- 13 Firing type. . . . . 41**
  - 13.1 Zero Crossing (ZC) . . . . . 41
  - 13.2 Burst Firing (BF) . . . . . 41
- 14 Internal Fuse . . . . . 42**

## 1

## Quick Start



**Attention:** this procedure must be carried out by skilled people only.

If your Custom HP code is in line with what you really need, then the main configuration is already done by Producer and you just need to do the following steps:

1. Verify Custom HP's current sizing. Be sure that:
  - the load current is equal or less than the nominal one of Custom HP
  - the main voltage is equal or less than the nominal voltage of Custom HP
2. Verify the Installation.
3. Verify the Wiring:
  - all auxiliary connections must be done in line with wirings on this manual
  - verify that there isn't a short circuit on the load
4. Supply the auxiliary voltage of the unit  
Give the main voltage supply.  
Enable the unit.

Activate the test (calibration) input terminal 2 on M5 to start the tuning load procedure.

The tuning procedure supply 100% of voltage to the load for 10sec and set in automatically mode:

- The load current  $A_{Lo}$  parameter
- The voltage on load  $U_{oP}$  parameter
- Set Heater break value setpoint.

### **This procedure must be done with the real load connected!**

The tuning of the load can be done also manually by setting the the parameters

$U_{oP}$  (Operative Voltage) and  $P_{Lo}$  (Nominal Power of the load) using the frontal keypad.

## 2 Basic Connections and sizing

### Star wiring with resistive load

$$I = \frac{P}{1,73V}$$

V = Nominal voltage of the load

I = Nominal current of the load

P = Nominal power of the load

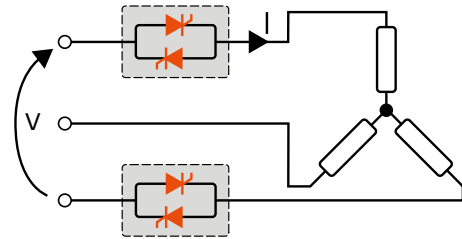

### Delta wiring with resistive load

$$I = \frac{P}{1,73V}$$

V = Nominal voltage phase to phase

I = Nominal current to the load

P = Nominal power to the load

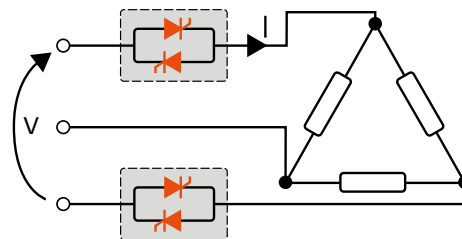

# 3 Identification and Order Code

## 3.1 Identification of the unit



**Caution:** Before to install, make sure that the Thyristor unit have not damages. If the product has a fault, please contact the dealer from which you purchased the product.

The identification's label give all the information regarding the factory settings of the Thyristor unit, this label is on the unit, like represented in figure. Verify that the product is the same thing as ordered.



### 3.1.1 Order code

|                       | 1        | 2        | 3 | 4 | 5 | 6 | 7 | 8 | 9 | 10 | 11 | 12 | 13 | 14 | 15 | 16 |
|-----------------------|----------|----------|---|---|---|---|---|---|---|----|----|----|----|----|----|----|
| <b>CUSTOM 2 Phase</b> | <b>C</b> | <b>2</b> | - | - | - | - | - | - | - | -  | -  | -  | -  | -  | -  | -  |

| <b>CURRENT</b> | 3    | 4 | 5 | 6 |
|----------------|------|---|---|---|
| description    | code |   |   |   |
| 1100A          | 1    | 1 | 0 | 0 |
| 1400A          | 1    | 4 | 0 | 0 |
| 1600A          | 1    | 6 | 0 | 0 |
| 1800A          | 1    | 8 | 0 | 0 |
| 2100A          | 2    | 1 | 0 | 0 |

| <b>MAX VOLTAGE</b> | 7    |
|--------------------|------|
| description        | code |
| 480V               | 4    |
| 600V               | 6    |
| 690V               | 7    |

| <b>VOLTAGE SUPPLY AUX</b>                    | 8    |
|--|------|
| description                                  | code |
| No external power supply internal connection | 1    |
| 170:265V external voltage supply             | 2    |

| <b>INPUT</b>                             | 9    |
|--|------|
| description                              | code |
| SSR                                      | S    |
| 0:10V dc                                 | V    |
| 4:20 mA                                  | A    |
| Potentiometer with internal power supply | K    |

| <b>FIRING</b>  | 10   |
|--|------|
| description  | code |
| Zero Crossing with SSR input                                   | Z    |
| Burst Firing settable from 1 to 255 cycles at 50% power demand | B    |

| <b>CONTROL MODE</b> | 11   |
|---------------------|------|
| description         | code |
| Open Loop           | 0    |
| Voltage feed back   | U    |
| Power feed back     | W    |
| Current feed back   | I    |

| <b>OPTION</b>  | 12   |
|--|------|
| description  | code |
| Measurement package including heater break alarm and current, voltage and power read out | H    |

| <b>FAN VOLTAGE</b> | 13   |
|--------------------|------|
| description        | code |
| Fan 220V           | 2    |

| <b>APPROVALS</b>                  | 14   |
|-----------------------------------|------|
| description                       | code |
| CE-EMC + IP0 protection standard  | 0    |
| CE-EMC + IP20 protection (option) | 3    |

| <b>MANUAL</b> | 15   |
|---------------|------|
| description   | code |
| None          | 0    |
| Italian       | 1    |
| English       | 2    |
| German        | 3    |
| French        | 4    |

| <b>LOAD CONNECTION</b>                               | 16   |
|--|------|
| description  | code |
| Std with phase mounted side by side 2-3 PH version   | 1    |
| Phase one on the top of phase two with air deflector | 2    |

# 4 Technical Specifications

## 4.1 General features

|  |   |
|--|---|
| Utilization Category                             | AC-51   |
| IP Code  | 00 (ip20 on request)  |
| Method of Connecting                             | Load in Delta, Load in Star (no neutral connection)   |
| Auxiliary voltage available:<br>(see order code) | 90:130V (10 VA Max)<br>170:265V (10 VA Max)<br>230:345V (10 VA Max)<br>300:530V (10 VA Max)<br>510:690V (10 VA Max) |
| Relay output alarm:                              | 0,5A a 125VAC   |

## 4.2 Input features

|                        |  |
|------------------------|--|
| Logic input SSR:       | 4 ÷ 30Vdc 5mA Max (ON ≥ 4Vdc OFF < 1Vdc) 5Hz max         |
| Volt Analogic input    | 0 ÷ 10Vdc impedance 15 K ohm                             |
| Current Analogic input | 0 ÷ 20mA impedance 100 ohm<br>4 ÷ 20mA impedance 100 ohm |
| POT                    | 10 K ohm min.  |
| Digital Input          | 4 ÷ 24Vdc 5mA Max (ON ≥ 4Vdc OFF < 1Vdc)                 |

## 4.3 Output features 600V

| Current | Output Voltage range (Ue) | Repetitive peak reverse voltage (Uimp) | Latching current | Max peak one cycle | Leakage current | FUSE I2T value Suggested Azs (at 660V) | Frequency range | Power loss Thyristor + Fuse | FANS       |                     |                       |
|---------|---------------------------|--|------------------|--------------------|-----------------|--|-----------------|-----------------------------|------------|---------------------|-----------------------|
|         |                           |  |                  |                    |                 |  |                 |                             | I=Inom (W) | N'                  | W                     |
| (A)     | (V)                       | (up to 600V)                           | (mAeff)          | (10msec.) (A)      | (mAeff)         | tp=10msec                              | (Hz)            |                             |            |                     |                       |
| 1100A   | 24÷600                    | 1800                                   | 700              | 22400              | 300             | 480.000                                | 47÷70           | 2698                        | 2          | 150<br>(75 x 2 Fan) | 1560<br>(780 x 2 Fan) |
| 1400A   | 24÷600                    | 1800                                   | 700              | 22400              | 300             | 1.750.000                              | 47÷70           | 3646                        | 4          | 300<br>(75 x 4 Fan) | 3120<br>(780 x 4 Fan) |
| 1600A   | 24÷600                    | 1600                                   | 700              | 26900              | 300             | 2.200.000                              | 47÷70           | 3722                        | 4          | 300<br>(75 x 4 Fan) | 3120<br>(780 x 4 Fan) |
| 1800A   | 24÷600                    | 1800                                   | 700              | 36000              | 300             | 2.200.000                              | 47÷70           | 4162                        | 4          | 300<br>(75 x 4 Fan) | 3120<br>(780 x 4 Fan) |
| 2100A   | 24÷600                    | 1600                                   | 700              | 38000              | 300             | 3.700.000                              | 47÷70           | 4722                        | 4          | 300<br>(75 x 4 Fan) | 3120<br>(780 x 4 Fan) |

## 4.4 Output features 690V

| Current | Output Voltage range (Ue) | Repetitive peak reverse voltage (Uimp) | Latching current | Max peak one cycle | Leakage current | FUSE I2T value Suggested Azs (at 660V) | Frequency range | Power loss Thyristor + Fuse | FANS       |                     |                       |
|---------|---------------------------|--|------------------|--------------------|-----------------|--|-----------------|-----------------------------|------------|---------------------|-----------------------|
|         |                           |  |                  |                    |                 |  |                 |                             | I=Inom (W) | N'                  | W                     |
| (A)     | (V)                       | (up to 690V)                           | (mAeff)          | (10msec.) (A)      | (mAeff)         | tp=10msec                              | (Hz)            |                             |            |                     |                       |
| 1100A   | 24÷690                    | 2200                                   | 700              | 36000              | 300             | 1.900.000                              | 47÷70           | 2674                        | 2          | 150<br>(75 x 2 Fan) | 1560<br>(780 x 2 Fan) |
| 1400A   | 24÷690                    | 2200                                   | 700              | 36000              | 300             | 3.300.000                              | 47÷70           | 3620                        | 4          | 300<br>(75 x 4 Fan) | 3120<br>(780 x 4 Fan) |
| 1600A   | 24÷690                    | 2200                                   | 700              | 36000              | 300             | 3.900.000                              | 47÷70           | 4258                        | 4          | 300<br>(75 x 4 Fan) | 3120<br>(780 x 4 Fan) |
| 1800A   | 24÷690                    | 2200                                   | 700              | 60000              | 300             | 3.900.000                              | 47÷70           | 3998                        | 4          | 300<br>(75 x 4 Fan) | 3120<br>(780 x 4 Fan) |
| 2100A   | 24÷690                    | 2200                                   | 700              | 60000              | 300             | 3.900.000                              | 47÷70           | 4710                        | 4          | 300<br>(75 x 4 Fan) | 3120<br>(780 x 4 Fan) |

### 4.5 Environmental installation conditions

|                     |  |
|---------------------|--|
| Ambient temperature | 0-40°C (32-104°F) at nominal current.<br>Over 40°C -104°F use the derating curve.  |
| Storage temperature | -25°C to 70°C -13°F to 158°F   |
| Installation place  | Don't install at direct sun light, where there are conductive dust, corrosive gas, vibration or water and also in salty environmental. |
| Altitude            | Up to 1000 meter over sea level. For higher altitude reduce the nominal current of 2% for each 100m over 1000m                         |
| Humidity            | From 5 to 95% without condense and ice   |
| Pollution Level     | Up to 2nd Level ref. IEC 60947-1 6.1.3.2   |

### 4.6 Derating Curve and Thermal conditions

The nominal current of the units in specification are referred to continuous service at 40° ambient temperature. For higher temperature multiply the nominal current times derating coefficient K below represented:

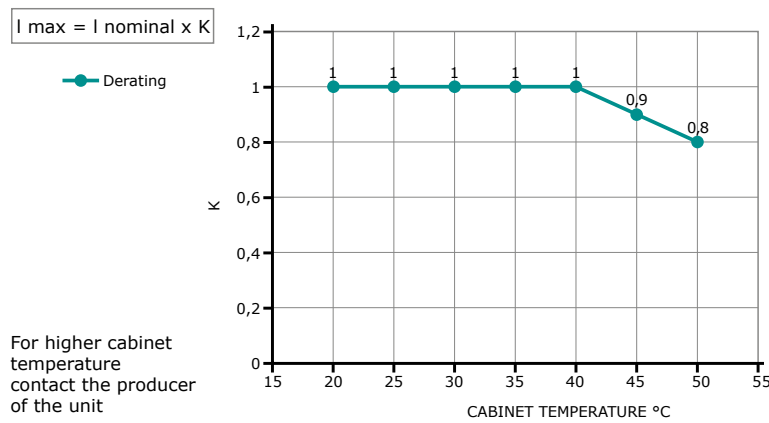

### 4.7 Calculating flow capacity of the fan

All the thyristor units when are in conduction produces power loss that is dissipated inside cubicle in terms of heating. Due to this fact the internal temperature of cubicle is higher than ambient temperature. To be cooled the thyristor need of fresh air cooling and to do it is normally used a fan mounted on the front door or on the roof of the cabinet.

Procedure to size **Fan air mass flow (V)**: see power loss for each thyristor and fuse mounted indicated in the manual related to the current (Output feature and Internal fuse Chapter).

|                                 |  |   |
|---------------------------------|--|---|
| $V = f * \frac{Q_v}{t_c - t_a}$ | <b>Q<sub>v</sub></b> = total power losses (w)<br>(thyristor + fuse power loss)<br><b>t<sub>a</sub></b> = ambient temperature (°C)<br><b>t<sub>c</sub></b> = cabinet temperature (°C)<br><b>V</b> = fan air mass flow (m <sup>3</sup> /h)<br><b>f</b> = altitude coefficient (see table on right) | <b>Altitude</b><br>0:100 meters <b>f = 3.1</b> m <sup>3</sup> k/W/h<br>100:250 meters <b>f = 3.2</b> m <sup>3</sup> k/W/h<br>250:500 meters <b>f = 3.3</b> m <sup>3</sup> k/W/h<br>500:750 meters <b>f = 3.4</b> m <sup>3</sup> k/W/h |
|---------------------------------|--|---|



The formulas used are for information only and is not a substitute for a proper thermal rating done by a qualified person.

# 5 Installation

Before to install, make sure that the Thyristor unit have not damages. If the product has a fault, please contact the dealer from which you purchased the product. Verify that the product is the same thing as ordered.

The Thyristor unit must be always mounted in vertical position to improve air cooling on heat-sink.

Maintain the minimum distances in vertical and in horizontal as represented, this area must be free from obstacle (wire, copper bar, plastic channel).

When more unit has mounted inside the cabinet maintain the air circulation like represented in figure without obstacle for the air flow.

Is necessary to install a fan to have better air circulation as calculated previously.

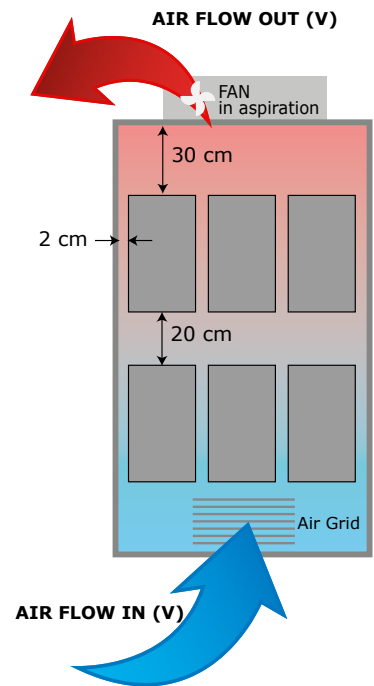

## 5.1 Dimensions and Weight



**1100A**  
A: 550mm - Weight: 49 Kg



**1400A-1600A-1800A-2100A**  
A: 740mm - Weight: 65 Kg



5.2 Fixing holes

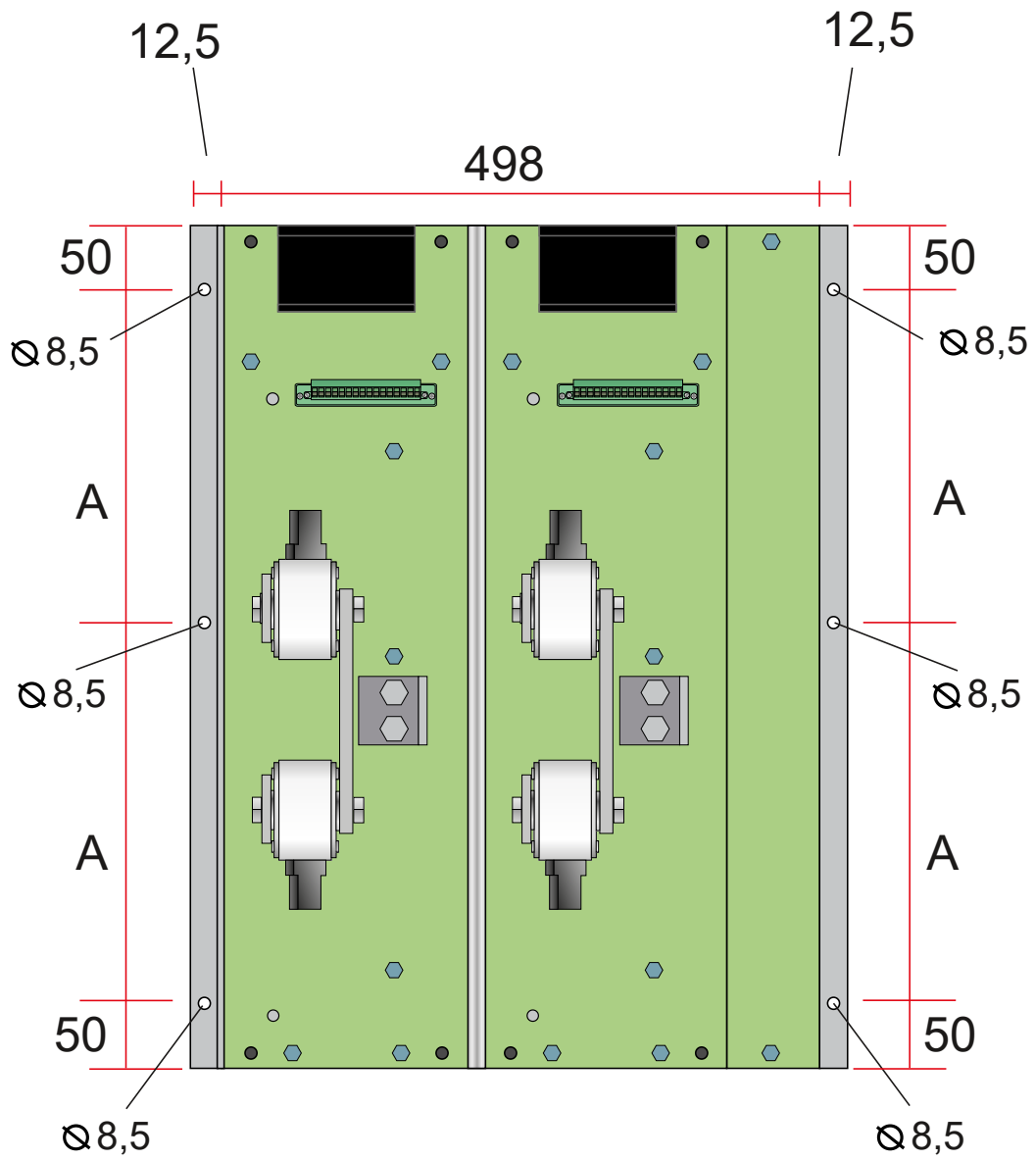

6 X M8

1100A  
A: 217,5mm

1400A-1600A-1800A-2100A  
A: 267,5mm

# 6 Wiring instructions

The Thyristor unit could be susceptible to interferences lost by near equipments or by the power supply, for this reason in accord to the fundamental practices rules is opportune take some precautions:

- The coil contactor, the relays and other inductive loads must be equipped with opportune RC filter.
- Use shielded bipolar cables for all the input and output signals.
- The signal cables must not be near and parallel to the power cables.
- Local regulations regarding electrical installation should be rigidly observed.

Use copper cables and wires rated for use at 75°C only.

## 6.1 Terminals Positions

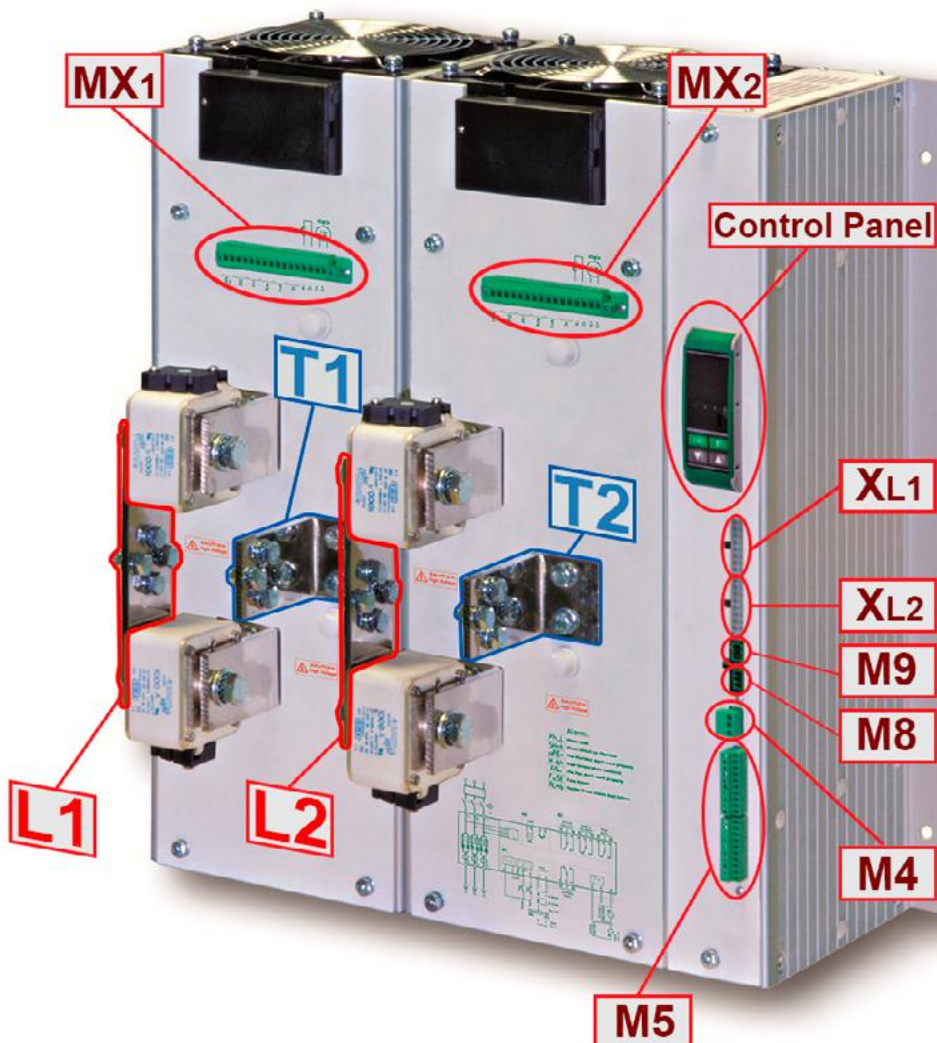

### 6.2 Power Terminals



**Warning:** Before connecting or disconnecting the unit check that power and control cables are isolated from voltage sources.

| Terminal | Description         |
|----------|---------------------|
| L1       | Line Input Phase 1  |
| L2       | Line Input Phase 2  |
| T1       | Load Output Phase 1 |
| T2       | Load Output Phase 2 |

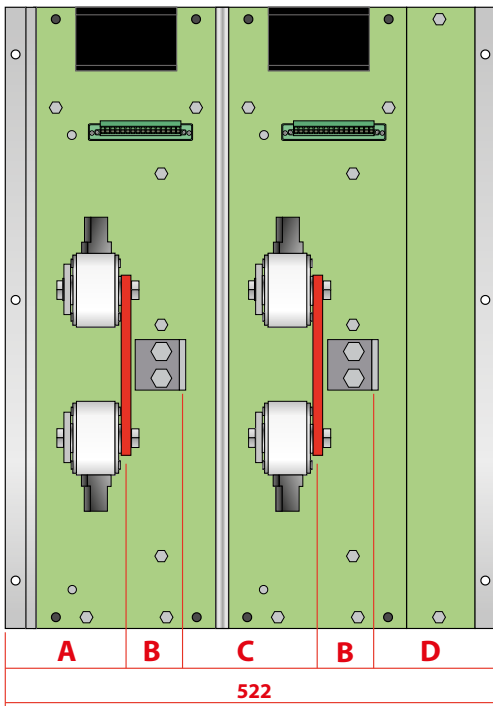
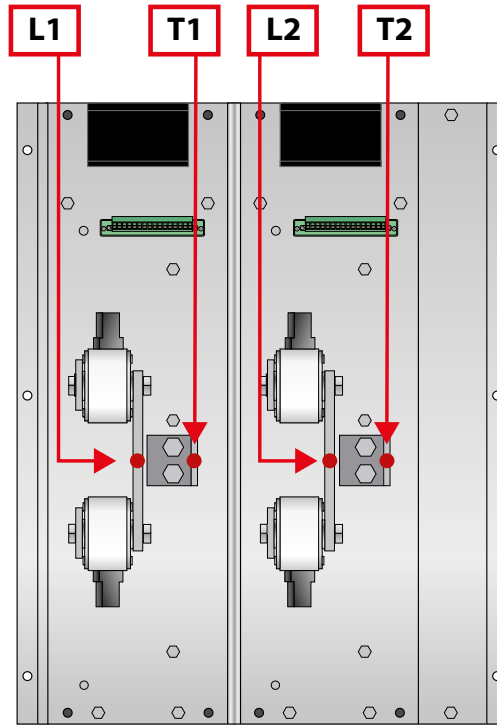

| 600V        |          |           |            |            |
|-------------|----------|-----------|------------|------------|
| 1100A-1400A | A: 124mm | B: 54,5mm | C: 140,5mm | D: 150,5mm |
| 1600A-1800A | A: 125mm | B: 52,5mm | C: 142,5mm | D: 151,5mm |
| 2100A       | A: 138mm | B: 38,5mm | C: 156,5mm | D: 152,5mm |
| 690V        |          |           |            |            |
| 1100A-1400A | A: 136mm | B: 42,5mm | C: 152,5mm | D: 150,5mm |
| 1600A-1800A | A: 137mm | B: 40,5mm | C: 154,5mm | D: 151,5mm |

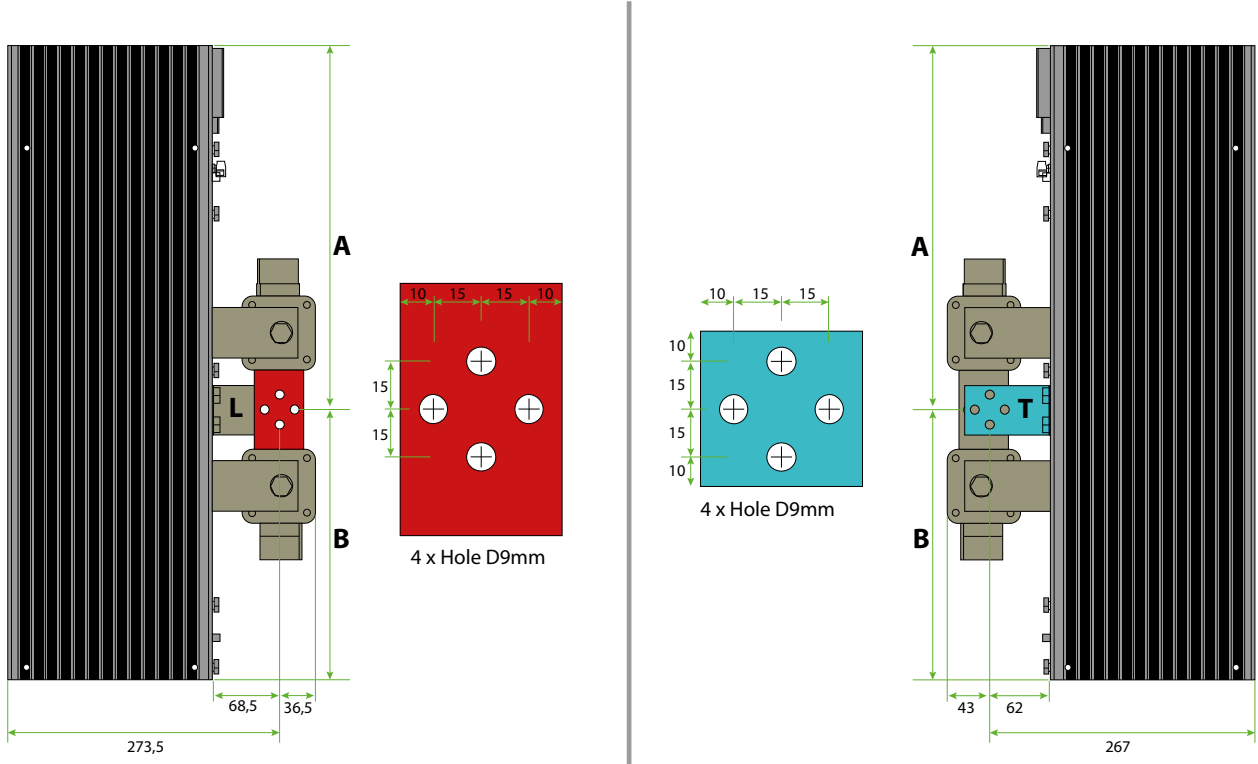

|                                |                 |                 |
|--------------------------------|-----------------|-----------------|
| <b>1100A</b>                   | <b>A:</b> 315mm | <b>B:</b> 220mm |
| <b>1400A-1600A-1800A-2100A</b> | <b>A:</b> 365mm | <b>B:</b> 270mm |

### 6.3 IP20 Cover OPTION

#### 6.3.1 Removing the IP20 cover

For each phase:

- \*1 Unscrew the two bottom M6 screws.
- \*2 Pull out the bottom cover.
- \*3 Unscrew the two upper M6 screws.
- \*4 Pull out the upper cover.

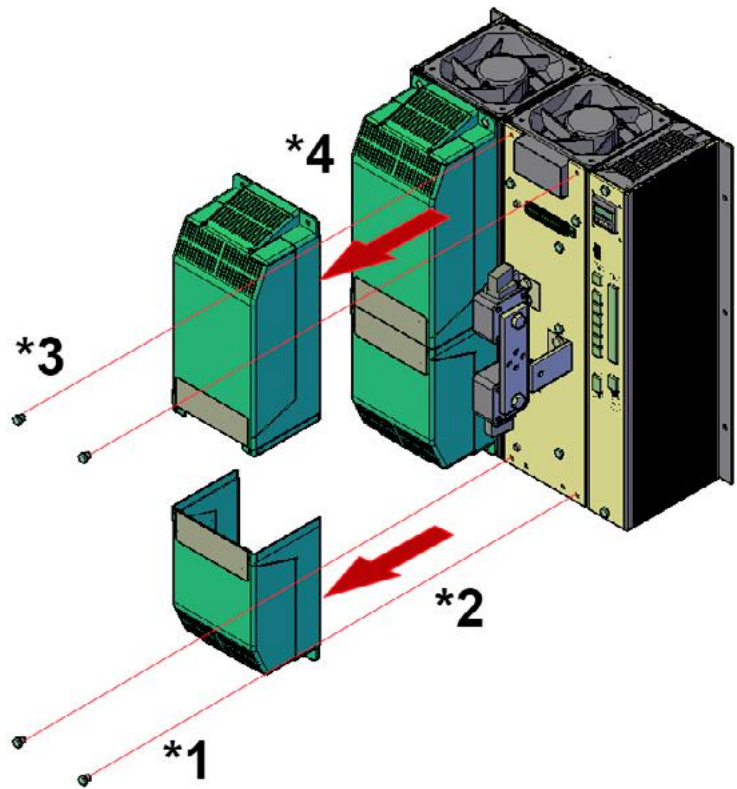

#### 6.3.2 IP20 Cover dimension

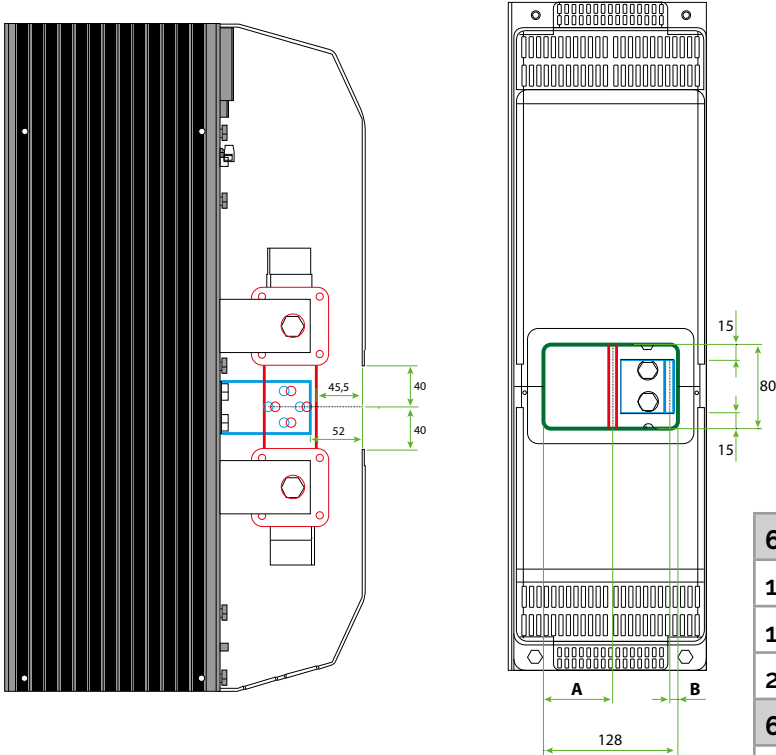

| 600V              |         |         |
|-------------------|---------|---------|
| 1100A             | A: 64mm | B: 10mm |
| 1400A-1600A-1800A | A: 65mm | B: 11mm |
| 2100A             | A: 80mm | B: 12mm |
| 690V              |         |         |
| 1100A             | A: 78mm | B: 10mm |
| 1400A-1600A-1800A | A: 79mm | B: 11mm |

### 6.4 Power cable dimensions (suggested)

| Current     | Supply          |         | Load            |         |
|-------------|-----------------|---------|-----------------|---------|
|             | Bar type        | Screw M | Bar type        | Screw M |
| 1100A-1400A | Bus Bar 50x6mm  | 4xM8    | Bus Bar 50x6mm  | 4xM8    |
| 1600A-1800A | Bus Bar 50x8mm  | 4xM8    | Bus Bar 50x8mm  | 4xM8    |
| 2100A       | Bus Bar 50x10mm | 4xM8    | Bus Bar 50x10mm | 4xM8    |

### 6.5 Cable dimensions (suggested) of Earth and of the Command Terminals

| Current     | Earth           |       |       | Command Terminals |     |
|-------------|-----------------|-------|-------|-------------------|-----|
|             | Cable           |       | Screw | Cable             |     |
|             | mm <sup>2</sup> | AWG   | M     | mm <sup>2</sup>   | AWG |
| 1100A       | 95              | 3/0   | M8    | 0,50              | 18  |
| 1400A       | 120             | 4/0   | M8    | 0,50              | 18  |
| 1600A-2100A | 2x95            | 2x3/0 | M8    | 0,50              | 18  |

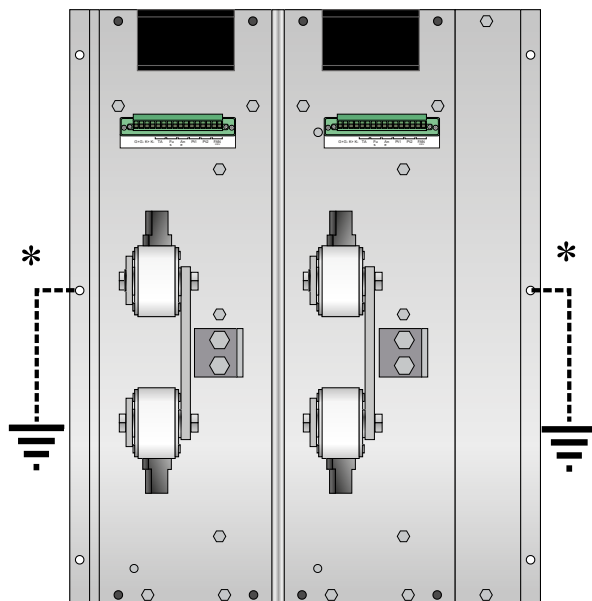

\* Earth connection on left side OR right side

## 6.6 Command Terminals



**Warning:** Before connecting or disconnecting the unit check that power and control cables are isolated from voltage sources.

### 6.6.1 Terminal M5

| Terminal | Description                          |
|----------|--------------------------------------|
| 1        | Enable Digital Input                 |
| 2        | Test / Configurable Input            |
| 3        | COM I - Common Digital Input         |
| 4        | 0V GND                               |
| 5        | Output +10Vdc stabilized 20 mA MAX   |
| 6        | - Control Input (SSR/0-10Vdc/4-20mA) |
| 7        | + Control Input (SSR/0-10Vdc/4-20mA) |
| 8        | Output + 24Vdc stabilized 20 mA MAX  |
| 9        | 0V GND                               |
| 10       | Option                               |
| 11       | 0V GND                               |

| Terminal | Description   |
|----------|---|
| 12       | NC - Normally Close contact alarm relay output (HB in alarm) *      |
| 13       | C - Common contact alarm relay output (HB) *                        |
| 14       | NO - Normally Open contact alarm relay output (HB in alarm) *       |
| 15       | NC - Normally Close contact alarm relay output (GENERAL in alarm) * |
| 16       | C - Common contact alarm relay output (GENERAL) *                   |
| 17       | NO - Normally Open contact alarm relay output (GENERAL in alarm) *  |
| 18       | NC - Normally Close contact alarm relay output (FUSE in alarm) *    |
| 19       | C - Common contact alarm relay output (FUSE) *                      |
| 20       | NO - Normally Open contact alarm relay output (FUSE in alarm) *     |

\* See Digital Output chapter for important details.

### 6.6.2 Terminal M4

| Terminal | Description   |
|----------|---|
| 1        | Aux - Voltage Supply for electronic boards 230V (120 as option) |
| 2        | Not Connected   |
| 3        | Aux - Voltage Supply for electronic boards 230V (120 as option) |

**6.6.3 Terminal MX 1-2**

| Terminal | Description                                     |
|----------|---|
| 1        | Internal Connection (G+)                        |
| 2        | Internal Connection (K+)                        |
| 3        | Internal Connection (G-)                        |
| 4        | Internal Connection (K-)                        |
| 5        | Internal Connection (Current Transformer)       |
| 6        | Internal Connection (Current Transformer)       |
| 7        | Internal Connection (Fuse fault Switch)         |
| 8        | Internal Connection (Fuse fault Switch)         |
| 9        | Internal Connection (Fan fault Switch)          |
| 10       | Internal Connection (Fan fault Switch)          |
| 11       | Internal Connection (PT1 Thermal Switch)        |
| 12       | Internal Connection (PT1 Thermal Switch)        |
| 13       | PT2 Thermal Switch                              |
| 14       | PT2 Thermal Switch                              |
| 15       | Fan supply voltage (230V standard - 115 option) |
| 16       | Fan supply voltage (230V standard - 115 option) |

**6.6.4 Terminal Mg**

| Terminal | Description   |
|----------|---------------|
| 1        | L3            |
| 2        | Not Connected |

**6.6.5 Terminal M8**

| Terminal | Description              |
|----------|--------------------------|
| 1        | C.T. Current Transformer |
| 2        | Not Connected            |
| 3        | C.T. Current Transformer |



### 6.7 Fan Supply For Each Phase (MX1 – MX2)

| Terminal | Description                                     |
|----------|---|
| 15       | Fan supply voltage (230V standard – 115 option) |
| 16       | Fan supply voltage (230V standard – 115 option) |

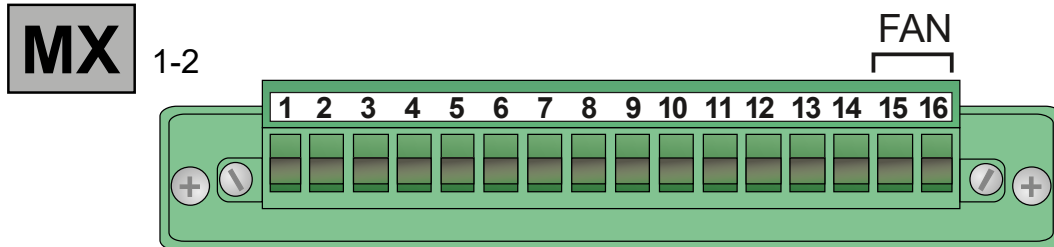

### 6.8 Thermal Switch For Each Phase (MX1 – MX2)

| Terminal | Description        |
|----------|--------------------|
| 13       | PT2 Thermal Switch |
| 14       | PT2 Thermal Switch |

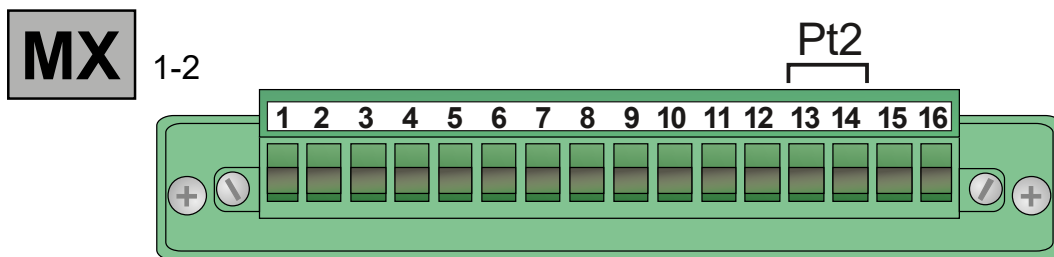

### 6.9 Schematic



**Caution:** this procedure must be performed only by qualified persons.

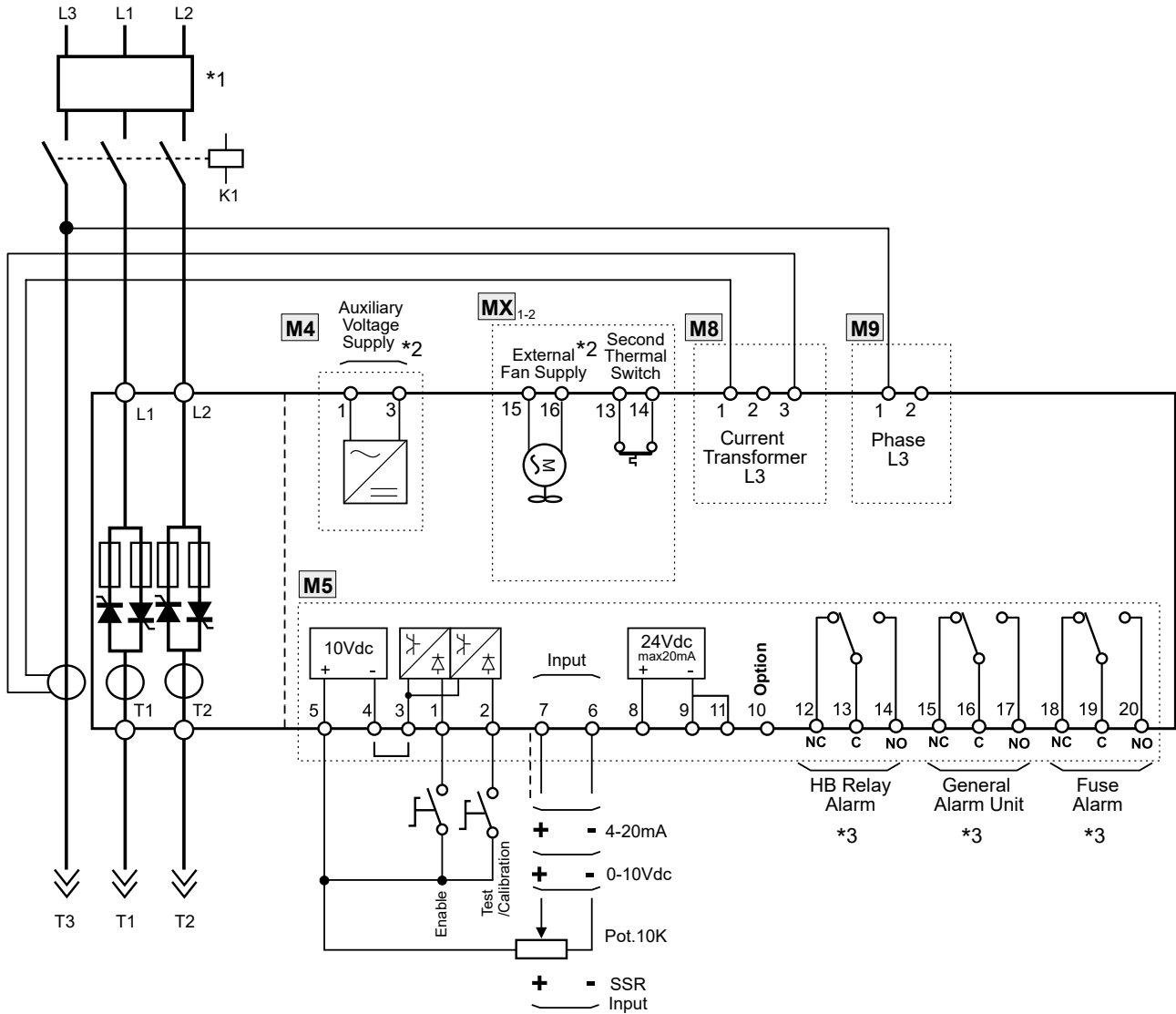

**NOTE:**

- \*1 The user installation must be protecting by electromagnetic circuit breaker or by fuse isolator. The semiconductor I<sub>2t</sub> should be 20% less than power controller I<sub>2t</sub>. Semiconductor fuses are classified for UL as supplementar protection for semiconductor. They are note approved for branch circuit protection.
- \*2 For the Voltage value see order code (230V-120V)
- \*3 See Digital Output chapter for important details.

**Note:** with the SSR signal the SSR input (M5 terminal 7,6) must be applied after the enable input

### 6.10 Connection Diagram for 3 phases (control on 2 phases)

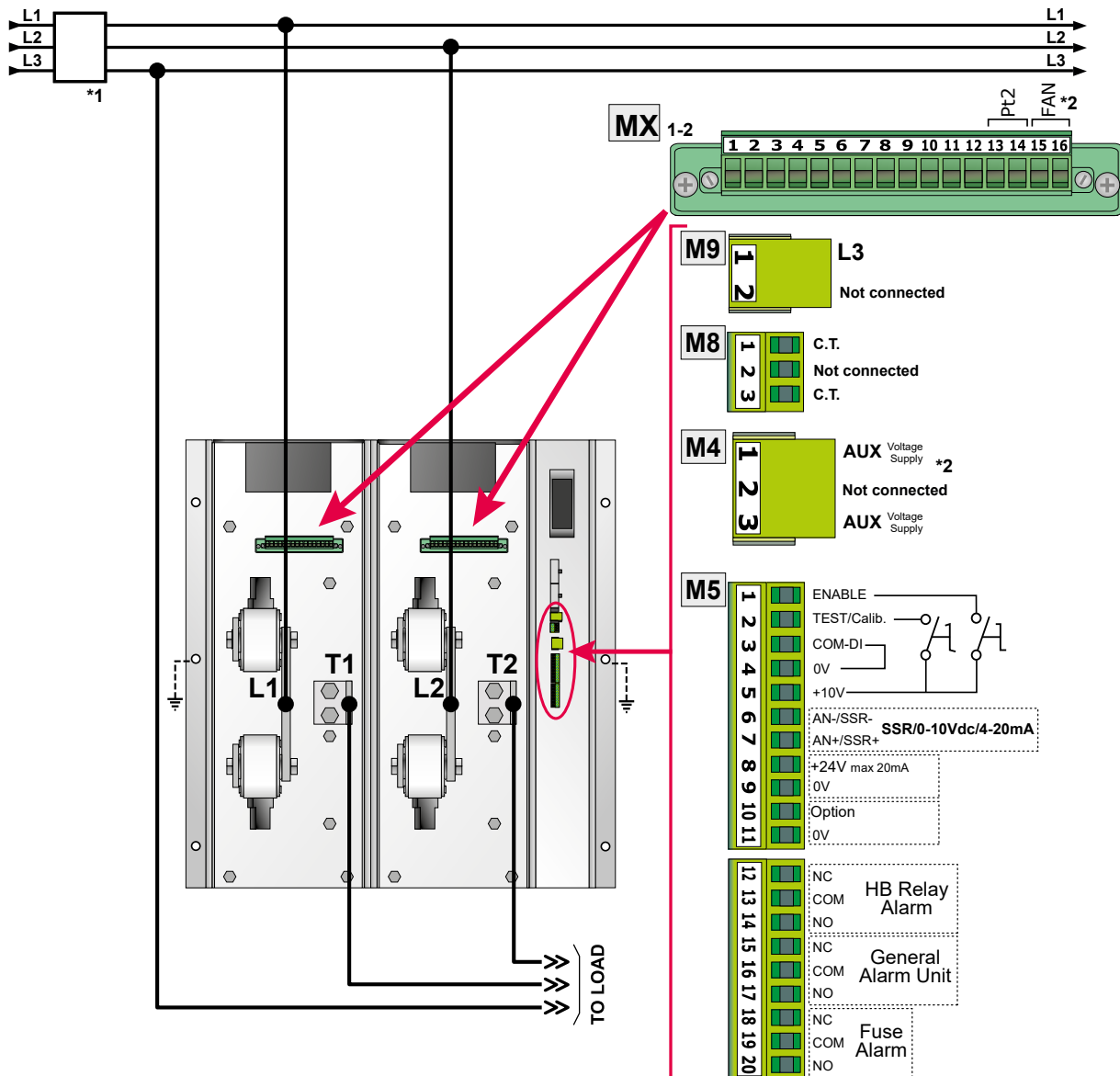

**\*1** The user installation must be protecting by electromagnetic circuit breaker or by fuse isolator. The semiconductor I<sub>2t</sub> should be 20% less than power controller I<sub>2t</sub>. Semiconductor fuses are classified for UL as supplemental protection for semiconductor.

**\*2** For the Voltage value see order code (230V-120V).

#### Load Type

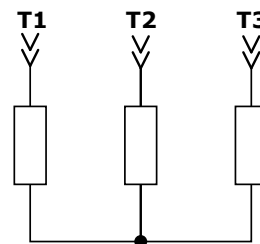
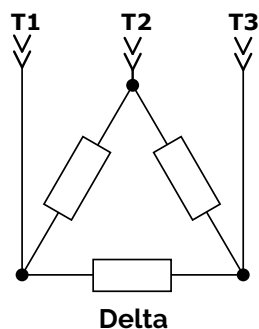

## 7

## Access to the Electronic Board

Remove the connectors, unscrew the two M6 screws as shown in picture, and pull out the board with the support.

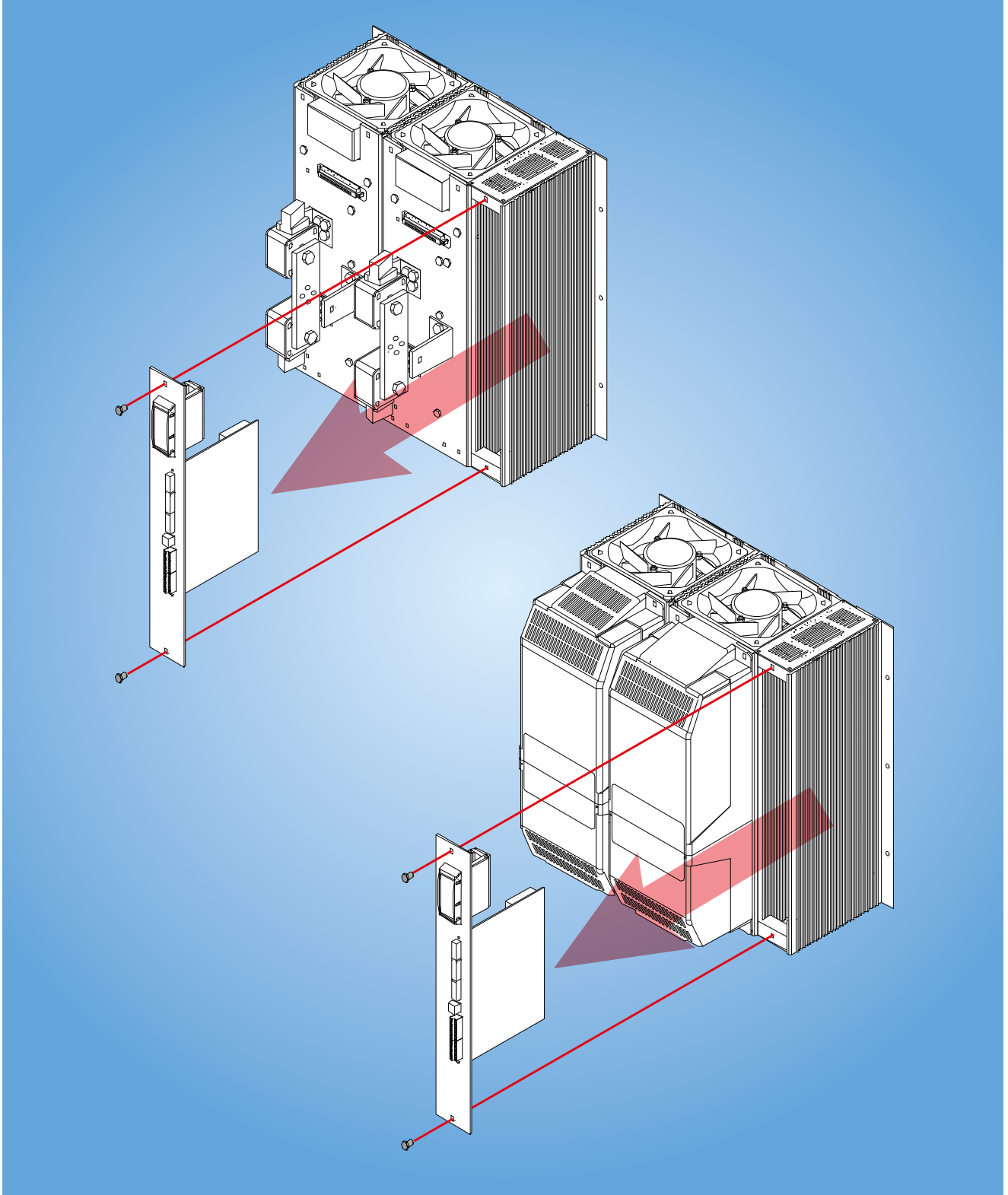

# 8 Supply the Electronic Board

The Custom HP thyristor unit, to work, requires a voltage supply for the electronic boards.  
The Max consumption is 10VA.

The voltage supply for the electronic boards is configured in line with customer requirements that are defined in the Order Code. The Order Code is written on the identification label.



**Warning:** Before connecting or disconnecting the unit check that power and control cables are isolated from voltage sources.

| Terminal | Description   |
|----------|---|
| 1        | Aux - Voltage Supply for electronic boards 230V (120 as option) |
| 2        | Not Connected   |
| 3        | Aux - Voltage Supply for electronic boards 230V (120 as option) |

To change auxiliary supply voltage sold the correct link-jumper on board:

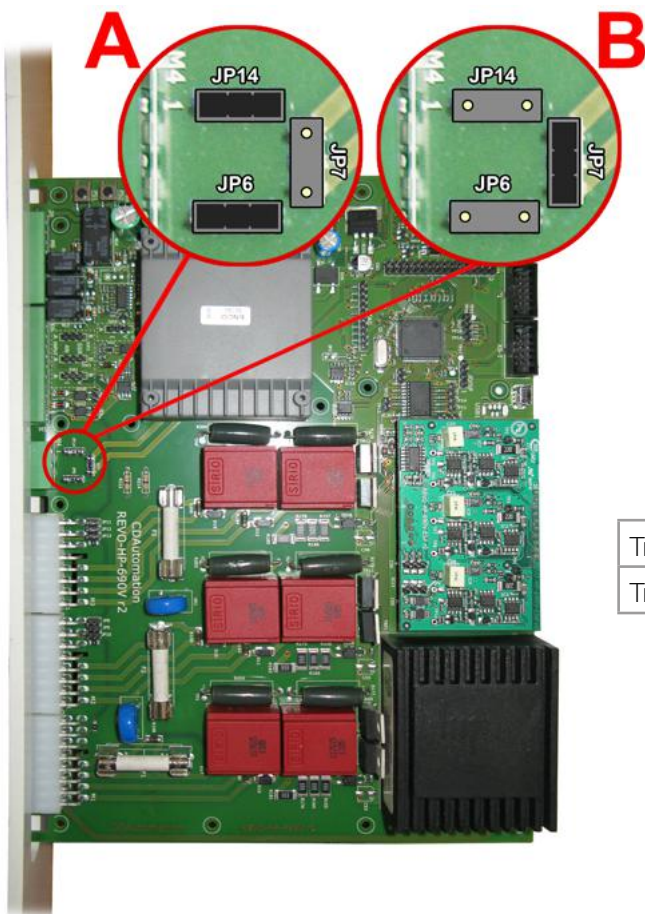

|               | Only Link-Jumper JP14+JP6 | Only Link-Jumper JP7 |
|---------------|---------------------------|----------------------|
| Transf. 30193 | 90÷130V                   | -                    |
| Transf. 30190 | 170÷265V                  | 300÷530V             |

If the Auxiliary Voltage (written on the identification label) is different from Supply Voltage (to the load), use an external transformer with primary equal to load voltage and secondary equal to the Auxiliary Voltage.

### 8.1 Fuse Board protection

The main board is protected with fuses.





# 9 Control Input type setting

The control input type is already configured in line with customer requirements that are defined in the Order Code. However, verify that the jumper are set as below represented:



**Warning:** Before operate, be sure that power and control cables are isolated from voltage sources

|            |                                   |       |       |       |
|------------|-----------------------------------|-------|-------|-------|
| <b>SSR</b> | <b>SSR Input</b> (see note below) | SW2=B | SW3=B | SW1=B |
| <b>V</b>   | <b>0-10V</b>                      | SW2=A | SW3=A | SW1=B |
| <b>I</b>   | <b>0-20mA 4-20mA</b>              | SW2=A | SW3=A | SW1=A |

**Note:** with the SSR signal the SSR input (M5 terminal 7,8) must be applied after the enable input so before to apply the SSR input signal the unit must be enabled

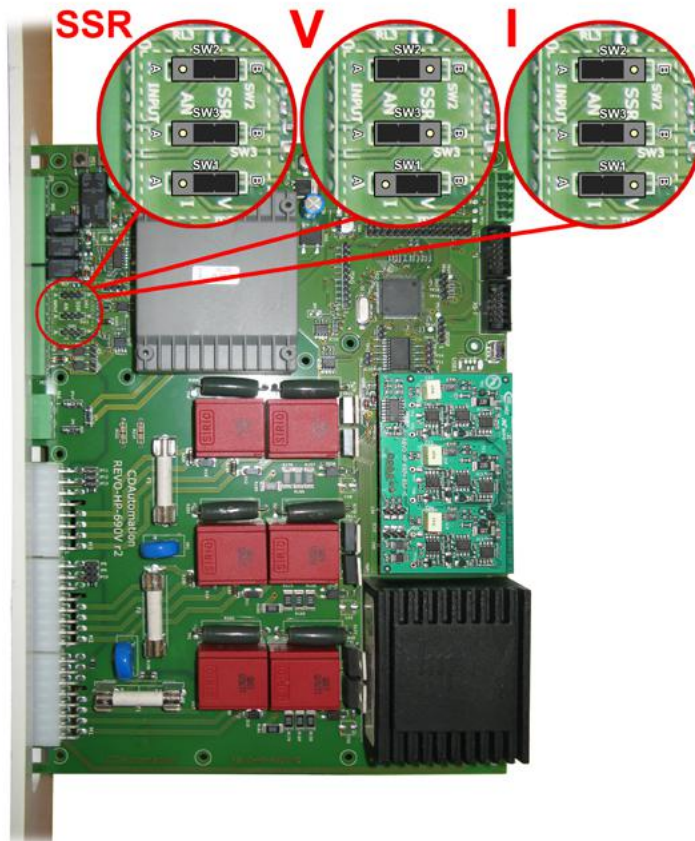

• Once the input is set with the jumpers set even with the Control Panel

**Control input type:**  $inP$  This parameter selects the type of control input. See Control panel chapter

|            |      |
|------------|------|
| 0 = 4-20mA | 4 20 |
| 1 = 4-20mA | 0 20 |
| 2 = V      | U    |
| 3 = SSR    | SSr  |

# 10 Input output signal

## 10.1 Digital Input

The Custom thyristor unit has 2 digital inputs opto-isolated to 24Vdc 5 mA. You can activate the inputs with the internal supply or with an external source for example the PLC.

### 10.1.1 Configurable Inputs (Terminal 1 -2 of M5)

Both digital inputs are configured by the parameter `[d 1]` and `[d 2]` could perform different functions:

- **None:** no function used `nonE`
- **Enable** (default for input 1): This is the start command (Enable) of the Custom unit.  
If you Remove the Start command the Custom thyristor unit will be stopped and the output will return at zero. `EnAb`  
Before to apply the SSR input signal the unit must be enabled.
- **Test/Calibration** (default for input 2): when activated the unit drive the load at 100% and stores the Current, Voltage and power value. `ALb`
- **Local Remote:** with this function, when you active the input, the setpoint reference change from Analog input to Digital value in bumpless mode, setted in the parameter `r`. The parameter `r` is not stored in memory. `LcrE`
- not used `rtrU`
- not used `F irr`
- **Reset Alarm:** when you active the input all the alarm are resetted. `ALrS`

## 10.2 Digital Output

The Custom HP unit is supplied with three relay output on terminal **M5**: Heater Break – General – Fuse alarm.

- In normal conditions, without alarm and with auxiliary power supply, the relay coil is energized.
- In alarm condition or without auxiliary power supply the relay coil is not energized.

For relay contact status see below.

| Terminal             | Without Aux Supply | Alarm  | No Alarm |
|----------------------|--------------------|--------|----------|
| <b>HB Relay</b>      |                    |        |          |
| 12-13                | Closed             | Closed | Open     |
| 13-14                | Open               | Open   | Closed   |
| <b>General Relay</b> |                    |        |          |
| 15-16                | Closed             | Closed | Open     |
| 16-17                | Open               | Open   | Closed   |
| <b>Fuse Relay</b>    |                    |        |          |
| 18-19                | Closed             | Closed | Open     |
| 19-20                | Open               | Open   | Closed   |



### 10.2.1 Configurable Outputs (Terminal 12 -13-14 and 15-16-17 of M5):

Two digital outputs are configured by the parameter *do 1* (HB Relay as default, terminal 12-13-14) and *do 2* (General, terminal 15-16-17) could perform different functions:

- **None:** no function used *nonE*
- **Enable:** when one of the input is in Enable mode the relay change status. *EnAb*
- not used *noAL*
- not used *SPH*
- **Phase loss:** when the voltage in one phase is zero the relay changes status. *noPH*
- **Fuse Fault:** when a fuse blow the relay changes status. *FUSE*
- **Fan Fault:** when one fan stop to work the relay changes status. *AnEn*
- **Thermal Switch:** when the temperature of heatsink cross the limit value the relay changes status. *ThEr*
- **Heater Break alarm:** when the HB alarm is active of heatsink the relay changes status. *Hb*
- **Short Circuit:** when a short circuit on thyristor is detected the relay changes status. *SHrt*
- **Any alarm:** any type of alarm changes status of relay. *Any*

# 11 Heater Break alarm and SCR short circuit (HB Option)



**Caution:** to work properly the load must be powered at least about 160msec.

The Heater Break circuit read the load resistance with an Internal voltage transducer and Internal current transformer (C.T.), to calculate the resistance (V/I).

Minimum current is 10% of the current transformer size.

If load current is below this value the Heater Break Alarm doesn't work properly.

## 11.1 Heater break Calibration procedure

An automatic function sets the Heater Break Alarm, when one of the configurable input is in **CALB** mode and input is on.

Digital input 2 is in calibration mode as default.

If the load resistance increases due to a partial or total load failure, the HB alarm become ON and alarm relay change status.

When the alarm condition disappear the alarm is resetted automatically.

You can Adjust the sensibility of HB alarm by using the parameter **Hb\_S**. This parameter is set between 1 and 255% of the nominal resistance.

This parameter is the maximum increment of the resistance Load to establish the HB Alarm.

There is also **Hb\_d** parameter to set a delay to have HB alarm active.

## 11.2 HB alarm contact

The Revo unit with HB option, is supplied with Heater Break alarm on terminal 12-13-14 of M5:

| Terminal        | Without Aux Supply | Alarm  | No Alarm |
|-----------------|--------------------|--------|----------|
| <b>HB Relay</b> |                    |        |          |
| 12-13           | Closed             | Closed | Open     |
| 13-14           | Open               | Open   | Closed   |



## 12

## Control Panel

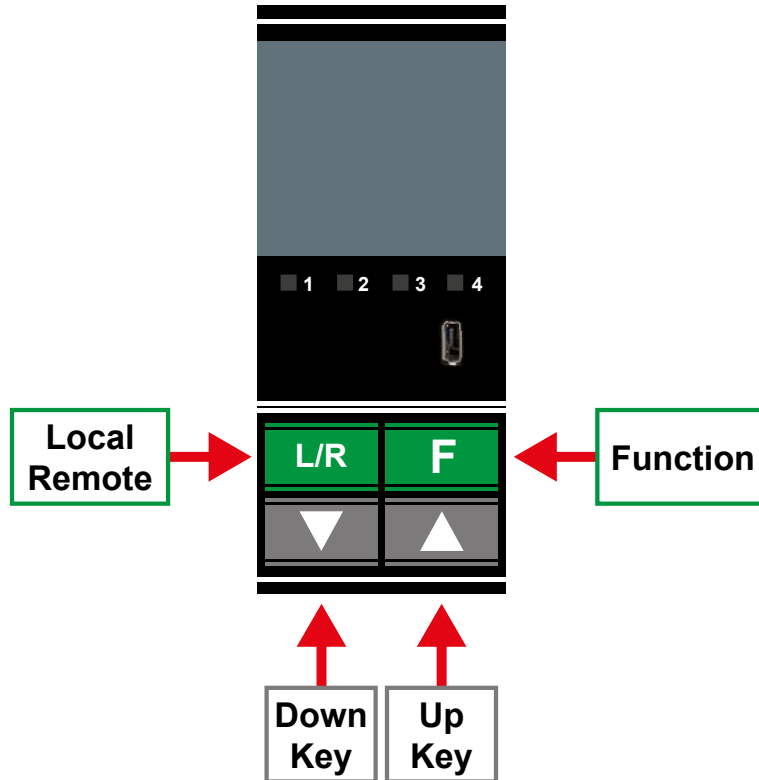
The Control Panel is placed on the front of the thyristor unit, on his display you can visualize the alarms, the input and output signals and all the configuration parameters.



The function keys are the following:

- The **Function key** **F** is used to scroll the parameter V Po Anp.
- The **UP key**  and **DOWN key**  are used to set the parameters in the menu and to change data.
- The **L/R key** is used to edit the parameters and to save the modified values.
- The **F** + **L/R** is used for enter and exit from the menu.

The Control Panel have three menu, and to enter in one of them you must set correctly the parameter *PASS*:

- **Operator Menu (*PASS* = 2)**  
This menu contains a reading parameters that give information on the state of the unit, it include also the base parameters for quick start, like the value of current and voltage load and the Set-point data.
- **Hardware Menu (*PASS* = 5)**  
This menu contains all the configuration parameters for analogic and digital I/O, and the parameters to set the serial port like the address and the baudrate.
- **Setup Menu (*PASS* = 10)**  
This menu contains all the setting parameters to configure the thyristor unit, like the firing type, the current limit, etc.

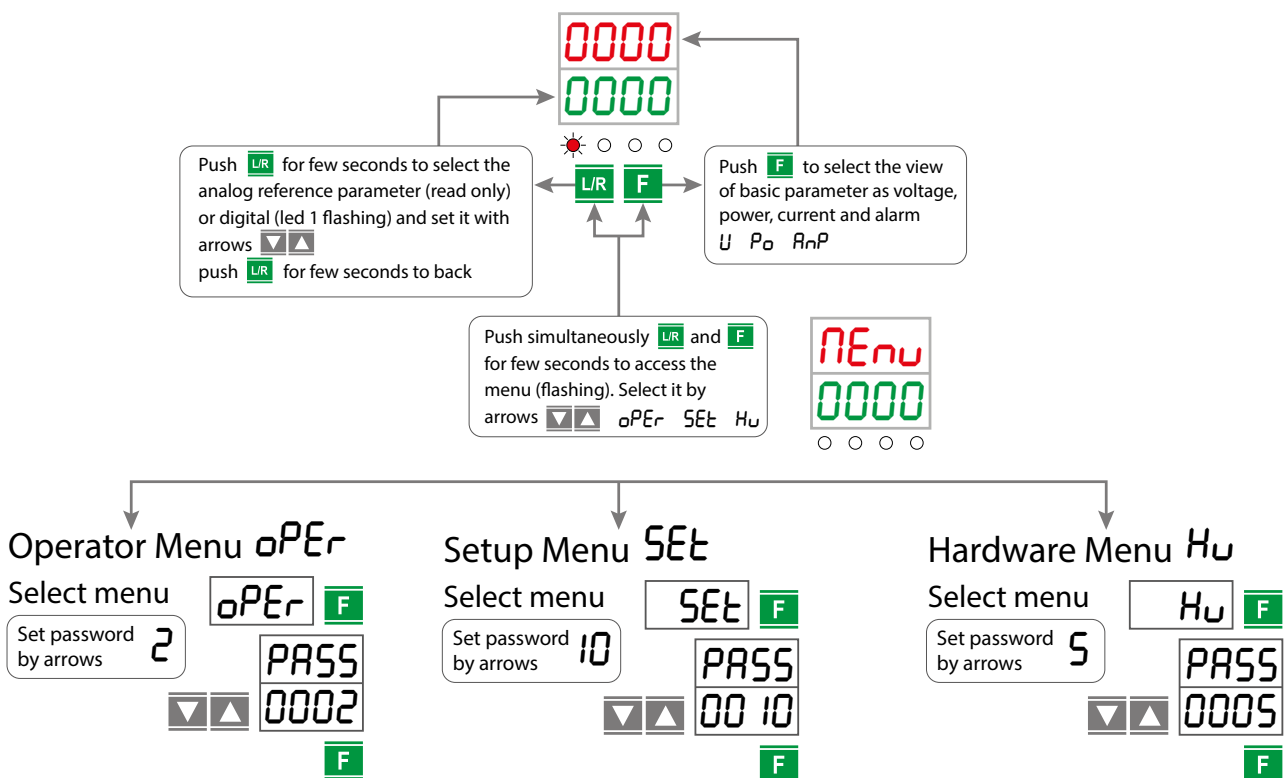

12.1 Scroll the parameters

Operator Menu *OPER*

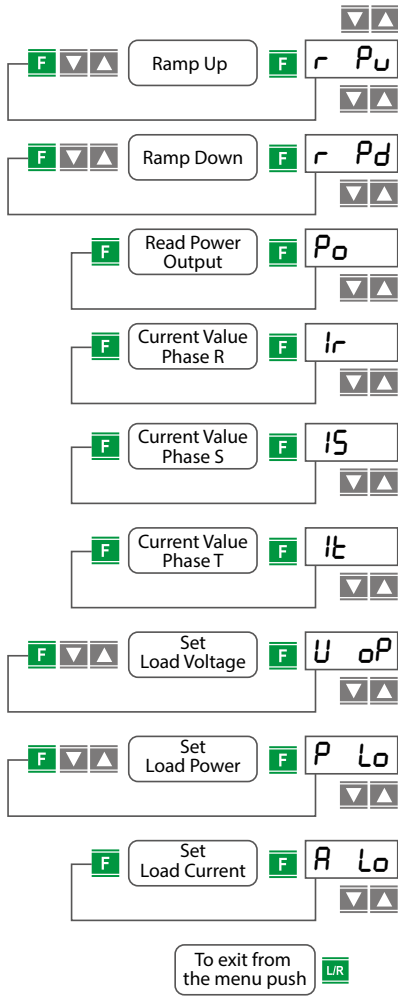

Setup Menu *SET*

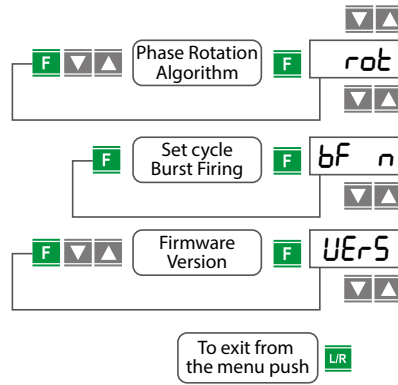

Hardware Menu *HU*

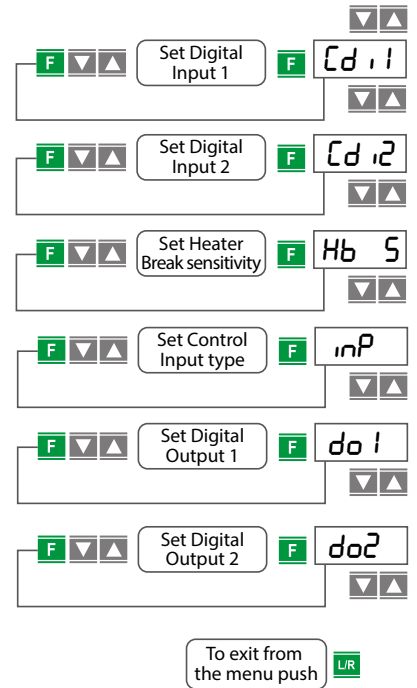

### 12.2 Operator Menu $\alpha P E r$

- Push simultaneously **L/R** and **F** for few seconds to access to the menu ( $n E n u$  flashing).
- Select by arrows **UP** and **DOWN** :  $\alpha P E r$  then press **F**.
- Select by arrows **UP** and **DOWN** :  $2$  as password then press **F**.
- You have access to the parameter on  $\alpha P E r$  menu.
- Select by arrows **UP** and **DOWN** the required parameter.
- If the parameter is **Write/Read (W/R)** press **F** (parameter flashing) then select by arrows **UP** and **DOWN** the required value, press **F** to set the new value.
- Push **L/R** to Exit from the menu
- **Ramp up:**  $r P u$  Is the settable time to reach the full thyristor conduction (100% output)
- **Ramp Down:**  $r P d$  Is the settable time to reach the zero thyristor conduction (0% output)
- **Read Power output:**  $P o$  This parameter shows the Average power output.
- **Current Value Phase R:**  $I r$  This parameter shows the instant value current output on phase R.
- **Current Value Phase S:**  $I S$  This parameter shows the instant value current output on phase S.
- **Current Value Phase T:**  $I t$  This parameter shows the instant value current output on phase T.
- **Set Load Voltage:**  $U \alpha P$  This parameter is used to set in Volt the operative voltage of the load.
- **Load nominal Power:**  $P L o$  This parameter is used to set in kWatt the nominal power of the load.
- **Load nominal Current:**  $A L o$  This parameter shows the current on the load.

### 12.3 Setup Menu $S E t$

- Push simultaneously **L/R** and **F** for few seconds to access to the menu ( $n E n u$  flashing).
- Select by arrows **UP** and **DOWN** :  $S E t$  then press **F**.
- Select by arrows **UP** and **DOWN** :  $10$  as password then press **F**.
- You have access to the parameter on  $S E t$  menu.
- Select by arrows **UP** and **DOWN** the required parameter.
- If the parameter is **Write/Read (W/R)** press **F** (parameter flashing) then select by arrows **UP** and **DOWN** the required value, press **F** to set the new value.
- Push **L/R** to Exit from the menu
- **Phase rotation Algorithm:**  $r o t$  This parameter enable or disable the phase rotation algorithm used to optimize and reduce the noise (only in burst firing)

| Sample Values and Note |          |
|------------------------|----------|
| $n o r t$              | Disabled |
| $r o t$                | Enabled  |

- **Burst Firing Cycles number:**  $b F n$  It defines the number of voltage cycles in ON condition at 50% of power demand.
- **Firmware version:**  $U E r S$  This parameter shows the firmware version number.

### 12.4 Hardware Menu *Hu*

- Push simultaneously **L/R** and **F** for few seconds to access to the menu (*Menu* flashing).
- Select by arrows **UP** and **DOWN: Hu** then press **F**.
- Select by arrows UP and **DOWN: 5** as password then press **F**.
- You have access to the parameter on *Hu* menu.
- Select by arrows **UP** and **DOWN** the required parameter.
- If the parameter is **Write/Read (W/R)** press **F** (parameter flashing) then select by arrows **UP** and **DOWN** the required value, press **F** to set the new value.
- Push **L/R** to Exit from the menu
- **Digital input 1 configuration:** *cd 1* This parameter selects the function of digital input 1 Terminal

| Sample Values and Note |             |
|------------------------|-------------|
| None                   | <i>nonE</i> |
| Enable the unit        | <i>EnAb</i> |
| Calibration            | <i>CALb</i> |
| Local Remote           | <i>LcrE</i> |
| Feedback Selection     | <i>rtrU</i> |
| Change Firing type     | <i>Firn</i> |
| Reset Alarm            | <i>ALrS</i> |

- **Digital input 2 configuration:** *cd 2* This parameter selects the function of digital input 2.

| Sample Values and Note |             |
|------------------------|-------------|
| None                   | <i>nonE</i> |
| Enable the unit        | <i>EnAb</i> |
| Calibration            | <i>CALb</i> |
| Local Remote           | <i>LcrE</i> |
| (not used)             | <i>rtrU</i> |
| (not used)             | <i>Firn</i> |
| Reset Alarm            | <i>ALrS</i> |

- **Set HB sensitivity:** *Hb 5*  
This parameter defines the threshold of resistance that activates the HB alarm  
This value is in percentage respect the nominal resistance load value
- **Control input type:** *InP* This parameter selects the type of control input.

|            |             |
|------------|-------------|
| 0 = 4-20mA | <i>4 20</i> |
| 1 = 4-20mA | <i>0 20</i> |
| 2 = V      | <i>U</i>    |
| 3 = SSr    | <i>SSr</i>  |

- **Digital Output 1 configuration:** *do1* This parameter selects the function of digital output1

| Sample Values and Note |             |                    |             |
|------------------------|-------------|--------------------|-------------|
| None                   | <i>nonE</i> | Fan Fault          | <i>RnEn</i> |
| Enable                 | <i>EnAb</i> | Thermal Switch     | <i>tHEr</i> |
| (not used)             | <i>noAL</i> | Heater Break alarm | <i>Hb</i>   |
| (not used)             | <i>SPH</i>  | Short Circuit      | <i>SHrE</i> |
| Phase loss             | <i>noPH</i> | Any alarm          | <i>RnY</i>  |
| Fuse Fault             | <i>FUSE</i> |                    |             |

- **Digital Output 2 configuration:** *do2* This parameter selects the function of digital input2

| Sample Values and Note |             |                    |             |
|------------------------|-------------|--------------------|-------------|
| None                   | <i>nonE</i> | Fan Fault          | <i>RnEn</i> |
| Enable                 | <i>EnAb</i> | Thermal Switch     | <i>tHEr</i> |
| (not used)             | <i>noAL</i> | Heater Break alarm | <i>Hb</i>   |
| (not used)             | <i>SPH</i>  | Short Circuit      | <i>SHrE</i> |
| Phase loss             | <i>noPH</i> | Any alarm          | <i>RnY</i>  |
| Fuse Fault             | <i>FUSE</i> |                    |             |

## 12.5 Displayed Alarms

| Alarm on Display | Description                   |
|------------------|-------------------------------|
| <i>Hb r</i>      | Heater Break Alarm phase R!   |
| <i>Hb S</i>      | Heater Break Alarm phase S!   |
| <i>Hb t</i>      | Heater Break Alarm phase T!   |
| <i>PHAS</i>      | Phase loss!                   |
| <i>FRn</i>       | Fan Fault!                    |
| <i>FUSE</i>      | Fuse Fault!                   |
| <i>tHS</i>       | Thermal Switch!               |
| <i>Sc r</i>      | Short Circuit on SCR Phase R! |
| <i>Sc S</i>      | Short Circuit on SCR Phase S! |
| <i>Sc t</i>      | Short Circuit on SCR Phase T! |



# 13 Firing type

Choose a correct firing type allows to optimize the thyristor unit for the installed load. The firing type has already configured in line with customer requirements, Zero Crossing for SSR input and Burst firing for Analog Input.



**Caution:** this procedure must be performed only by qualified persons.

## 13.1 Zero Crossing (ZC)

ZC firing mode is used with Logic Output from temperature controllers and the Thyristor operates like a contactor. The Cycle time is performed by temperature controller. ZC minimizes interferences because the Thyristor unit switches ON-OFF at zero voltage.

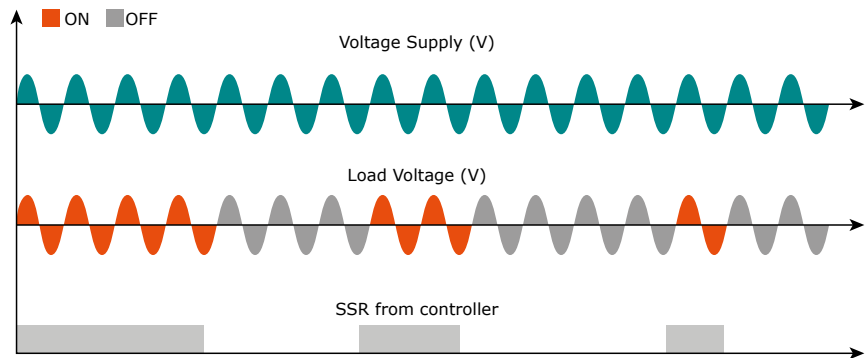

## 13.2 Burst Firing (BF)

The Burst Firing is similar to the Single Cycle, but consecutive cycles ON are selectable between 2 and 255, with input signal equal at 50%. Burst Firing is a method zero crossing that it reduces the electromagnetic interferences because the thyristor switches at zero voltage crossing. The example show the Burst Firing with Burst cycles: 4

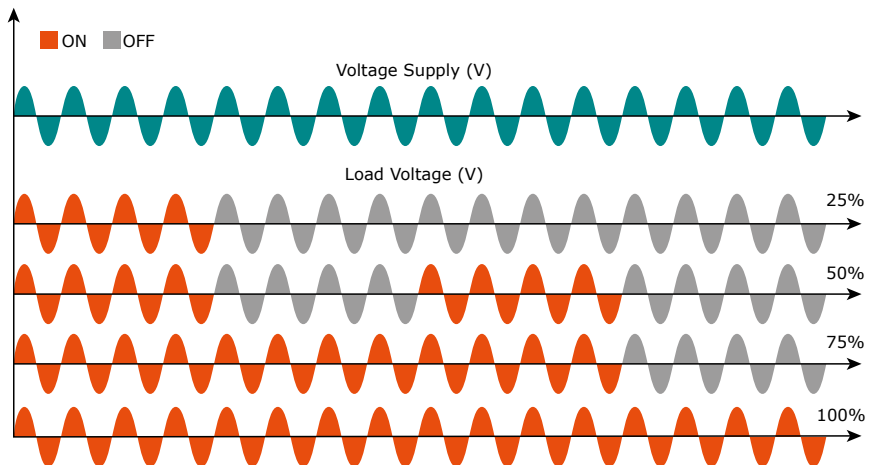

# 14 Internal Fuse

The thyristor unit have internal fuse extrarapid at low I<sup>2</sup>t for the thyristor protection of against the short-circuits. The Fuses must have I<sup>2</sup>t 20% less than thyristor's I<sup>2</sup>t. The warranty of thyristor is null if no proper fuses are used.

Remove cover, remove screws and fuses.

**TORQUE for M12 fuse screws min: 32 Nm to Max: 52 Nm**

## 600V

| Thyristor Size | Fuse CODE                  | 200 kARMS Symmetrical A.I.C. |                |   |     | Qty for each Phase |
|----------------|----------------------------|------------------------------|----------------|---|-----|--------------------|
|                |                            | Current (A RMS)              | Power Loss (W) | FUSE I <sup>2</sup> T value Suggested A <sup>2</sup> s (at 660V)* | Vac |                    |
| 1100A          | FU800SIB<br>SQB3 690-700V  | 800                          | 118            | 480.000   | 690 | 2                  |
| 1400A          | FU1250A<br>SQB3 690-700V   | 1250                         | 147            | 1.750.000   | 690 | 2                  |
| 1600A          | FU1400SIB<br>SQB3 690-700V | 1400                         | 161            | 2.200.000   | 690 | 2                  |
| 1800A          | FU1400SIB<br>SQB3 690-700V | 1400                         | 161            | 2.200.000   | 690 | 2                  |
| 2100A          | FU1600SIB<br>SQB3 600V     | 1600                         | 190            | 3.700.000   | 600 | 2                  |

\*I<sup>2</sup>T are multiplied for K value in function of Vac at 500V K is equal to 0,7 (ex:480.000 X 0,7 = 336.000). At 660Vsc K is equal to 1.

## 690V

| Thyristor Size | Fuse CODE               | 200 kARMS Symmetrical A.I.C. |                |  |      | Qty for each Phase |
|----------------|-------------------------|------------------------------|----------------|--|------|--------------------|
|                |                         | Current (A RMS)              | Power Loss (W) | FUSE I <sup>2</sup> T value Suggested A <sup>2</sup> s (at 1000V)* | Vac  |                    |
| 1100A          | FU1000SIB<br>SQB3 1000V | 1000                         | 150            | 1.900.000  | 1000 | 2                  |
| 1400A          | FU1250SIB<br>SQB3 900V  | 1250                         | 198            | 3.300.000  | 900  | 2                  |
| 1600A          | FU14000SIB<br>SQB3 900V | 1250                         | 210            | 3.900.000  | 900  | 2                  |
| 1800A          | FU1400SIB<br>SQB3 900V  | 1400                         | 210            | 3.900.000  | 900  | 2                  |
| 2100A          | FU1400SIB<br>SQB3 900V  | 1400                         | 210            | 3.900.000  | 900  | 2                  |

\*I<sup>2</sup>T are multiplied for K value in function of Vac at 700V K is equal to 0,73 (ex: 1.900.000 X 0,73= 1.387.000). At 1000Vsc K is equal to 1.



**Caution:** High speed fuses are used only for the thyristor protection and can not be used to protect the installation.



**Caution:** The warranty of thyristor is null if no proper fuses are used. See tab.



**Warning:** When it is supply, the Thyristor unit is subject to dangerous voltage, don't open the Fuse-holder module and don't touch the electric equipments.

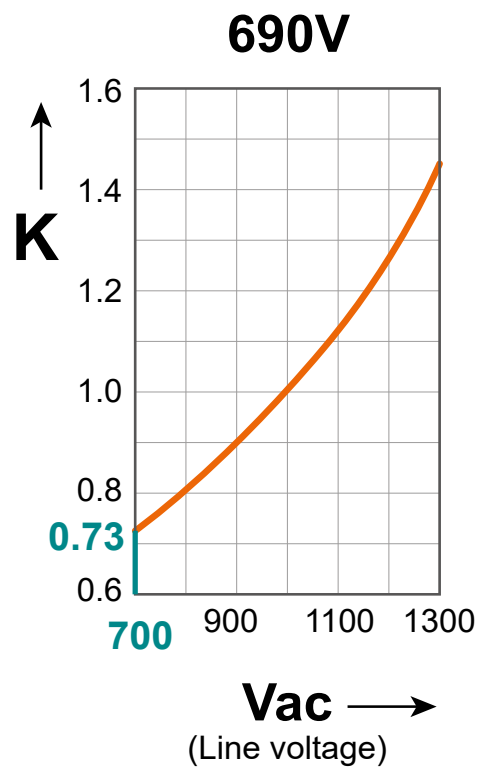
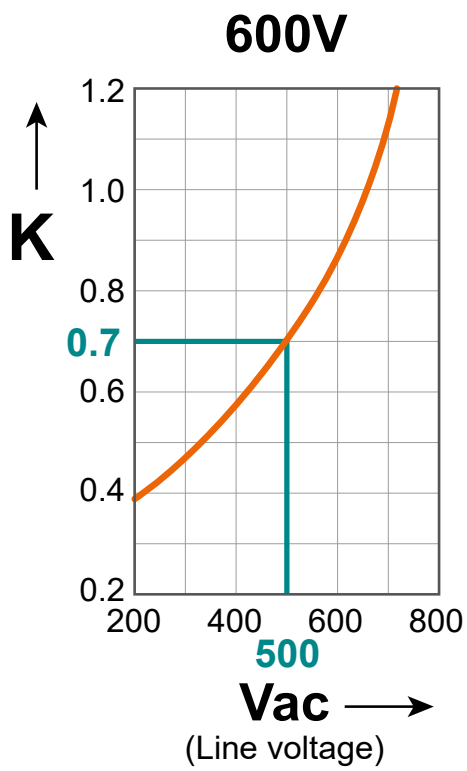



**CD Automation S.r.l.**

Via Picasso, 34/36 - 20025 Legnano (MI)- Italy

Tel. +39 0331 577479 - Fax +39 0331 579479

E-mail: [info@cdautomation.com](mailto:info@cdautomation.com) - Web: [www.cdautomation.com](http://www.cdautomation.com)