



**CD Automation S.r.l.**

Via Picasso, 34/36 - 20025 Legnano (MI)- Italy

Tel. +39 0331 577479 - Fax +39 0331 579479

E-mail: [info@cdautomation.com](mailto:info@cdautomation.com) - Web: [www.cdautomation.com](http://www.cdautomation.com)





## Declaration of conformity

### Declaration of conformity - Dichiarazione di Conformità

#### PRODUCT MANUFACTURER / PRODUTTORE:



**CD Automation S.R.L.**  
Controllers, Drives & Automation

Via Picasso, 34/36 - 20025 Legnano (MI)- Italy  
P.I. 08925720156 -Tel. +39 0331 577479 - Fax +39 0331 579479  
E-mail: info@cdautomation.com - Web: www.cdautomation.com

#### Declare that the product / Dichiaro che il prodotto:

**Revo S 1PH 30-40A**

PRODUCT DESCRIPTION: Electric power control  
SCOPE OF APPLICATION: Thermal control process  
DESCRIZIONE DEL PRODOTTO: Unità di controllo potenza elettrica  
UTILIZZO: Controllo processi termici

#### FULFILLS THE REQUIREMENTS OF THE STANDARD:

Electrical safety Standard	EN60947-1: 2007 + A1 2011, A2 2014 EN60947-4-3: 2014
Generic Emission standard	EN60947-4-3: 2014 Group 1 Class A emissions
Generic Immunity standard	EN60947-4-3: 2014 Industrial Immunity

#### SODDISFA I REQUISITI DELLA NORMA:

Specifica di sicurezza	EN60947-1: 2007 + A1 2011, A2 2014 EN60947-4-3: 2014
Specifica sulle emissioni	EN60947-4-3: 2014 gruppo 1 emissioni classe A
Specifica sulle Immunità	EN60947-4-3: 2014 Immunità industriale

CDAutomation declares that the products above mentioned are conforming to the directive  
CDAutomation dichiara che i prodotti sopra menzionati sono conformi alla direttiva  
Bassa Tensione (low Voltage) **EMC directive updated 2014/30/EU,**  
**Low Voltage Directive updated 2014/35/EU**

Issued on: 20/03/2017  
Data di emissione: 20/03/2017

Amministratore Unico e  
Legale Rappresentante







Claudio Brizzi

# Important warnings for safety

This chapter contains important information for the safety. The not observance of these instructions may result in serious personal injury or death and can cause serious damages to the Thyristor unit and to the components system included.

*The installation should be performed by qualified persons.*

In the manual are used symbols to give more evidence at the notes of safety and operativity for the attention for the user:

	This icon is present in all the operational procedures where the Improper operation may result in serious personal injury or death by Electrical Shock Hazard Symbol (a lightning bolt in a triangle) precedes an electric shock hazard CAUTION or WARNING safety statement.
	Warning or Hazard that needs further explanation than the label on unit can provide. Consult User's Guide for further information.
	Unit is compliant with European Union directives. See Declaration of Conformity for further details on Directives and Standards used for Compliance.
	If available, unit is a Listed device per Underwriters Laboratories. It has been investigated to ANSI/UL® 508 standards for Industrial Control Switches and equivalent to CSA C22.2 #14. For more detail search for File E231578 on www.ul.com
	ESD Sensitive product, use proper grounding and handling techniques when installing or servicing product.
	Do not throw in trash, use proper recycling techniques or consult manufacturer for proper disposal.

A "NOTE" marks a short message to alert you to an important detail.

A "CAUTION" safety alert appears with information that is important for protecting your equipment and performance. Be especially careful to read and follow all cautions that apply to your application.







A "WARNING" safety alert appears with information that is important for protecting you, others and equipment from damage. Pay very close attention to all warnings that apply to your application.

## Safety notes

 **WARNING!** To avoid damage to property and equipment, injury and loss of life, adhere to applicable electrical codes and standard wiring practices when installing and operating this product. Failure to do so could result in damage, injury and death.

 **AVERTISSEMENT!** Pour éviter d'endommager la propriété et l'équipement, les blessures et la perte de vie, respecter les codes électriques en vigueur et les pratiques de câblage standard au moment de l'installation et de l'utilisation de ce produit. Dans le cas contraire, cela peut entraîner la mort, des blessures graves ou des dommages.

-  **WARNING!** All service including inspection, installation, wiring, maintenance, troubleshooting, fuse or other user serviceable component replacement must be performed only by properly qualified personnel. Service personnel must read this manual before proceeding with work. While service is being performed un-qualified personnel should not work on the unit or be allowed in the immediate vicinity.
-  **AVERTISSEMENT!** Tous les services, y compris l'inspection, l'installation, le câblage, l'entretien, le dépannage, le remplacement de fusibles ou d'autres composants pouvant être réparés par l'utilisateur, doivent être effectués uniquement par un personnel d'entretien qualifié. Le personnel de service doit lire ce manuel avant d'effectuer tout travail. Pendant que l'entretien est exécuté, tout personnel non qualifié ne doit effectuer de travail sur l'appareil ni se trouver à proximité.
-  **WARNING!** When in use the power controller is connected to dangerous voltages. Do not remove the protective covers without first disconnecting and preventing power from being restored while servicing the unit.
-  **AVERTISSEMENT!** Au moment de l'utilisation, le régulateur de puissance est connecté à des tensions dangereuses. Ne retirer aucun couvercle de protection sans d'abord débrancher l'appareil et ainsi empêcher l'alimentation d'être rétablie pendant l'entretien.
-  **WARNING!** Do not use in aerospace or nuclear applications.
-  **AVERTISSEMENT!** Ne pas utiliser pour les applications aérospatiales ou nucléaires.
-  **WARNING!** The power controller's protection rating is IP20 with all covers installed and closed. It must be installed in an enclosure that provides all the necessary additional protections appropriate for the environment and application.
-  **AVERTISSEMENT!** L'indice de protection du régulateur de puissance est de IP20 lorsque les couvercles sont installés et fermés. L'appareil doit être installé dans une enceinte qui assure toute la protection supplémentaire nécessaire pour l'environnement et l'application.
-  **WARNING!** Ground the power controller via the provided protective earth grounding terminal. Verify ground is within impedance specifications. This should be verified periodically.
-  **AVERTISSEMENT!** Mise à la terre du régulateur de puissance par le biais de la borne de prise de terre de protection fournie. Vérifier que la prise de terre est conforme aux spécifications de l'impédance. Cela doit être vérifié périodiquement.
-  **WARNING!** Electric Shock Hazard: when the power controller has been energized, after shutting off the power, wait at least one minute for internal capacitors to discharge before commencing work that brings you in to contact with power connections or internal components.
-  **AVERTISSEMENT!** Risque de décharges électriques: lorsque le régulateur de puissance est mis sous tension, après avoir été éteint, attendre au moins une minute pour que les condensateurs internes se déchargent avant de commencer tout travail incluant le contact avec les connexions électriques ou les composants internes.
-  **WARNING!** The installation must be protected by electromagnetic circuit breakers or by fuses. The semiconductor fuses located inside the power controller are classified for UL as supplementary protection for semiconductor devices. They are not approved for branch circuit protection.
-  **AVERTISSEMENT!** L'installation doit être protégée par des disjoncteurs électromagnétiques ou des fusibles. Les fusibles pour semi-conducteurs situés à l'intérieur du régulateur de puissance sont classés UL comme protection supplémentaire pour les dispositifs pour semi-conducteurs. Ils ne sont pas approuvés pour la protection des circuits de dérivation.
-  **WARNING!** When making live voltage or current measurements, use proper personal protective equipment for the voltages and arc-flash potentials involved.

-  **AVERTISSEMENT!** Au moment de relever des mesures de tension ou de courant en direct, utiliser un équipement de protection individuelle approprié pour les tensions et les potentiels d'arc électrique concernés.
-  **WARNING!** Verify the voltage and current ratings of the power controller are correct for the application.
-  **AVERTISSEMENT!** Vérifier que les valeurs de tension et de courant du régulateur de puissance sont correctes pour l'application.
-  **CAUTION:** To avoid compromising the insulation, do not bend wire or other components beyond their bend radius specifications.
-  **ATTENTION:** Pour éviter de compromettre l'isolation, ne pas plier le fil ou tout autre composant au-delà de ses spécifications en matière de rayon de courbure.
-  **CAUTION:** Protect the power controller from high temperature, humidity and vibrations.
-  **ATTENTION:** Protéger le régulateur de puissance contre les températures élevées, l'humidité et les vibrations.
-  **CAUTION:** The power controller warranty is void if the tested and approved fuses are not used.
-  **ATTENTION:** La garantie du régulateur de puissance est nulle si aucun fusible testé et approuvé n'est utilisé.
-  **CAUTION:** Only trained and authorized personnel should access and handle the internal electronics and they must follow proper electro-static prevention procedures.
-  **ATTENTION:** Seul le personnel formé et autorisé peut accéder aux composants électroniques internes et les gérer, et il doit se conformer à des procédures de prévention électrostatique appropriées.
-  **CAUTION:** Install an appropriately sized RC filter across contactor coils, relays and other inductive loads.
-  **ATTENTION:** Installer un filtre RC de dimensions appropriées sur les bobines du contacteur, les relais et autres charges par induction.
-  **NOTE:** Provide a local disconnect to isolate the power controller for servicing.
-  **REMARQUE:** Fournir une déconnexion locale afin d'isoler le régulateur de puissance pour l'entretien.
-  **NOTE:** The nominal current is specified for ambient temperatures at or below 40° C. Ensure the application design allows for adequate cooling of each power controller. The power controller must be mounted vertically. The cooling design must prevent air heated by one power controller from causing power controllers mounted above to exceed the ambient operating temperature limit. When power controllers are mounted side by side allow a minimum spacing of 15mm between them.
-  **REMARQUE:** Le courant nominal est précisé pour des températures ambiantes égales ou inférieures à 40°C. S'assurer que la conception de l'application permette le refroidissement adéquat de chaque régulateur de puissance. Le régulateur de puissance doit être monté verticalement. La conception de refroidissement doit empêcher l'air chauffé par le régulateur de puissance de dépasser la limite de température de fonctionnement ambiante de la part des régulateurs de puissance montés au-dessus. Lorsque les régulateurs de puissance sont montés côte à côte, il faut conserver un espacement minimal de 15 mm entre les deux.
-  **NOTE:** Use only copper cables and wires rated for use at 90°C or greater.
-  **REMARQUE:** N'utiliser que des câbles et des fils en cuivre pour l'utilisation à 90°C ou plus.



## Maintenance

In order to have a corrected cooling, the user must clean the heat-sink and the protective grill of the fans. The frequency of this servicing depends on environmental pollution.

Also check periodically if the screw for the power cables and safety earth are tightened correctly (See Connection Diagram)

### Warranty condition

Producer gives a 12 months warranty to its products.

The warranty is limited to repairing and parts substitution in our factory and does exclude products not properly used and fuses.

Warranty does not include products with serial numbers deleted. The faulty product should be shipped to Producer at customer's cost and our Service will evaluate if product is under warranty terms.

Substituted parts remain of Producer property.



## Return Material Authorization (RMA)

Customers wishing to return any items, whether they are incorrectly supplied, faulty or damaged in transit, must first complete a Return Material Authorisation (RMA) form to obtain an RMA number from the Service Department.

A full repair service is available for customers. Prior to submitting the RMA form and returning products, customers are recommended to contact the technical support team to determine whether the issue can be resolved with telephone support.

### How the RMA service works

The RMA form and details are available on our web sites:

<https://www.cdautomation.com/returns-material-authorisation/>

When completing the RMA form, please be as specific as possible about the problem, including any pertinent application details. The more information given, the more quickly and more thoroughly the problem can be solved. The minimum information required is:

1. The Full Model Number
2. Quantity of units being returned
3. The units Serial Number(s)
4. A description of the problem ("faulty" or "unknown" is not sufficient)



# Summary

- Declaration of conformity. . . . . 3
- Important warnings for safety . . . . . 4
- Maintenance . . . . . 7
- 1 Basic Connections . . . . . 9
- 2 Order Code . . . . . 10
- 3 Technical Specifications. . . . . 11
  - General features . . . . . 11
  - Input features . . . . . 11
  - Output features (power device). . . . . 11
  - Environmental installation conditions. . . . . 12
  - Derating Curve. . . . . 12
- 4 Installation . . . . . 13
  - Dimensions and Fixing holes . . . . . 13
- 5 Wiring instructions . . . . . 14
  - Connection Diagram for Single-phase . . . . . 15
- 6 Firing type. . . . . 16
  - Zero Crossing . . . . . 16
- 7 External Fuse (not included) . . . . . 17
  - External Fuse-holder Dimension (not included) . . . . . 18
- 8 Trouble shooting. . . . . 19



1

# Basic Connections

Single phase wiring with resistive load

$$I = \frac{P}{V}$$

V = Nominal voltage of the load

I = Nominal current of the load

P = Nominal power of the load

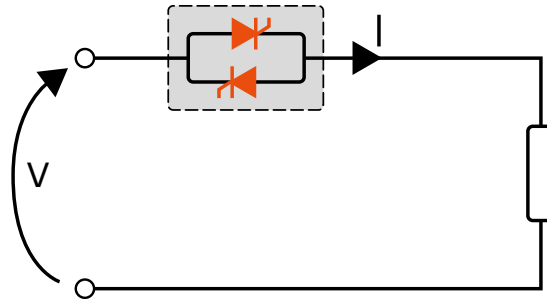

Open Delta wiring with resistive load

$$I = \frac{P}{3V}$$

V = Nominal voltage of the load

I = Nominal current of the load

P = Nominal power of the load

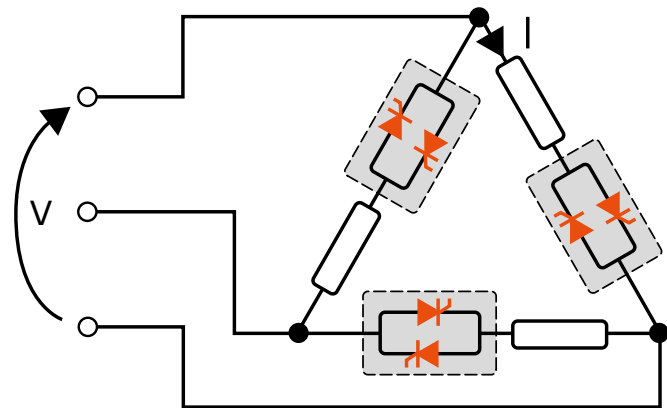

2

# Order Code

	<b>1</b>	<b>2</b>	<b>3</b>	<b>4</b>	<b>5</b>	<b>6</b>		<b>7</b>	<b>8</b>	<b>9</b>	<b>10</b>	<b>11</b>	<b>12</b>	<b>13</b>	<b>14</b>	<b>15</b>	<b>16</b>
<b>REVO S 1PH</b>	<b>R</b>	<b>S</b>	<b>1</b>	-	-	-	-	-	-	-	-	-	-	-	-	-	-

<b>CURRENT</b>	4	5	6
<b>description</b>	<b>code</b>		
30A	0	3	0
35A	0	3	5
40A	0	4	0

<b>MAX VOLTAGE</b>	7
<b>description</b>	<b>code</b>
480V	4
600V	6

<b>VOLTAGE SUPPLY AUX</b>	8
<b>description</b>	<b>code</b>
No Aux Voltage without HB and/or Analog Input up to 210A included	0
With HB and/or Analog Input on all unit ≤ 210A Aux Volt 12:24V ac-dc	4

<b>INPUT</b>	9
<b>description</b>	<b>code</b>
SSR	S
0:10V dc	V
4:20mA	A

<b>FIRING</b>	10
<b>description</b>	<b>code</b>
Zero Crossing ZC	Z
Burst Firing 4 Cycles On at 50% Power Demand	4
Burst Firing 8 Cycles On at 50% Power Demand	8
Burst Firing 16 Cycles On at 50% Power Demand	6

<b>CONTROL MODE</b>	11
<b>description</b>	<b>code</b>
Open Loop	0

<b>FUSES &amp; OPTION</b>	12
<b>description</b>	<b>code</b>
No Fuse	0
Fuse + Fuse Holder	F
Fuse + Fuse Holder + CT	Y
Fuse + Fuse Holder + CT + HB	H
Fuse + Fuse Holder + CT + HB with Flat Cable Connection	X

<b>FAN VOLTAGE</b>	13
<b>description</b>	<b>code</b>
No Fan < 90A	0

<b>APPROVALS</b>	14
<b>description</b>	<b>code</b>
CE EMC For European Market	0
CE EMC + cUL® listed and cULus 508® listed	L

<b>MANUAL</b>	15
<b>description</b>	<b>code</b>
None	0
Italian	1
English	2
German	3
French	4

<b>VERSION</b>	16
<b>description</b>	<b>code</b>
Std unit with one fuse only	1
High Sensitivity HB below 5A	5

3

## tions

### General features

Cover and Socket material:	PolymericV2
Mounting:	DIN bar (thickness type 1mm Max)
Utilization Category:	AC-51 AC-55b
IP Code:	20
Method of Connecting:	Single Phase load
Delay switch ON/OFF time:	1/2 Period Max

### Input features

Logic input SSR:	5 ÷ 30Vdc gmA Max (ON $\geq$ 5Vdc OFF <4Vdc)
------------------	--

### Output features (power device)

Nominal current in continuous service:	See order code
Max peak current (10ms):	360A for unit type 030 540A for unit type 035 700A for unit type 040
Nominal Voltage range <b>Ue</b> :	24÷600V
Repetitive peak reverse voltage <b>Uimp</b> :	1200V (480V) 1600V (600V)
Latching current:	250mA
Leakage current:	15mA eff
FUSE I <sup>2</sup> T value suggested at 500Vac tp=10msec:	525 A <sup>2</sup> s for unit type 030 1260 A <sup>2</sup> s for unit type 035 1260 A <sup>2</sup> s for unit type 040
Frequency range:	47÷70Hz
Power loss (I=Inom):	38W for unit type 030 44W for unit type 035 50W for unit type 040
Isolation Voltage <b>Ui</b> :	2500Vac

### Environmental installation conditions

Ambient temperature	0-40 °C (32-104 °F) at nominal current. Over 40°C use the derating curve.
Storage temperature	-25°C to 70°C, -13°F to 158°F
Installation place	Don't install at direct sun light, where there are conductive dust, corrosive gas, vibration or water and also in salty environmental.
Altitude	Up to 1000 meter over sea level. For higher altitude reduce the nominal current of 2% for each 100m over 1000m
Humidity	From 5 to 95% without condense and ice
Pollution Level	Up to 2nd Level ref. IEC 60947-1 6.1.3.2

### Derating Curve

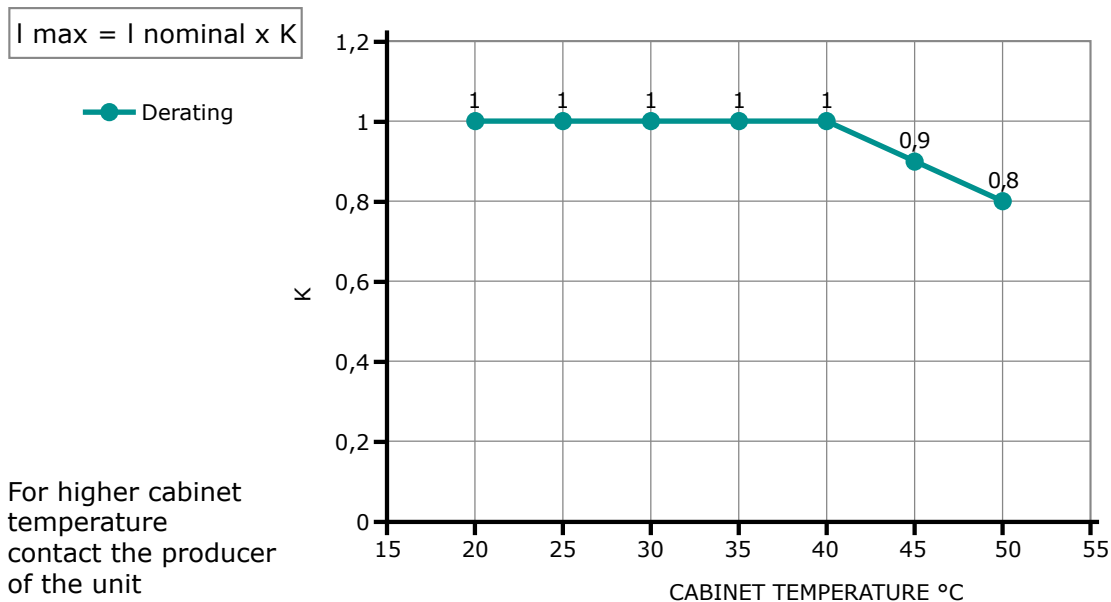

# 4 Installation

Before to install, make sure that the Thyristor unit have not damages.

If the product has a fault, please contact the dealer from which you purchased the product. Verify that the product is the same thing as ordered.

The Thyristor unit must be always mounted in vertical position to improve air cooling on heat-sink.

Maintain the minimum distances in vertical and in horizontal as represented.

When more unit has mounted inside the cabinet maintain the air circulation like represented in figure.

Sometimes is necessary installing a fan to have better air circulation.

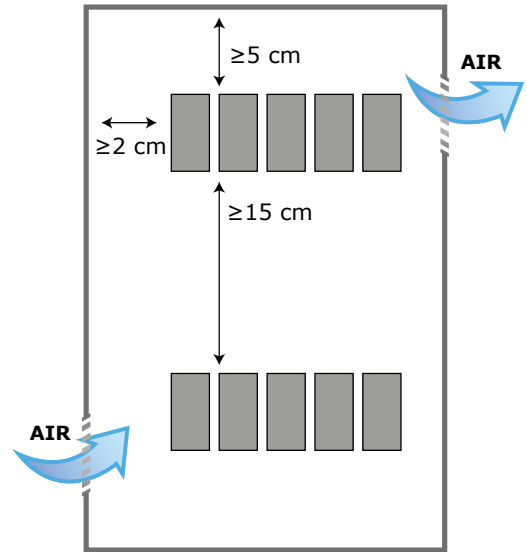

## Dimensions and Fixing holes

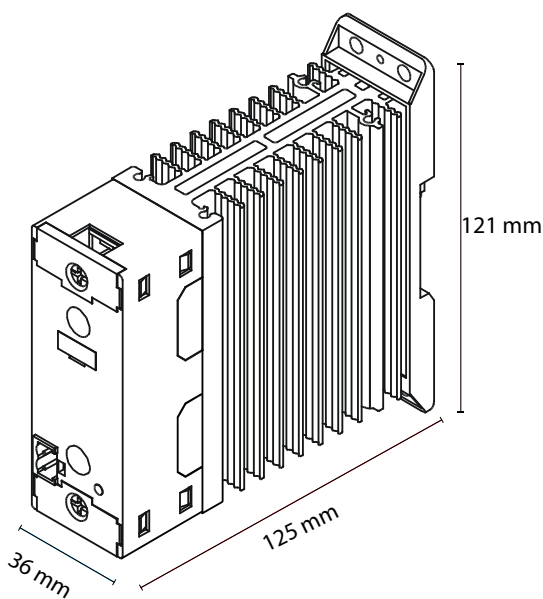

<b>Weight</b>
0,44Kg

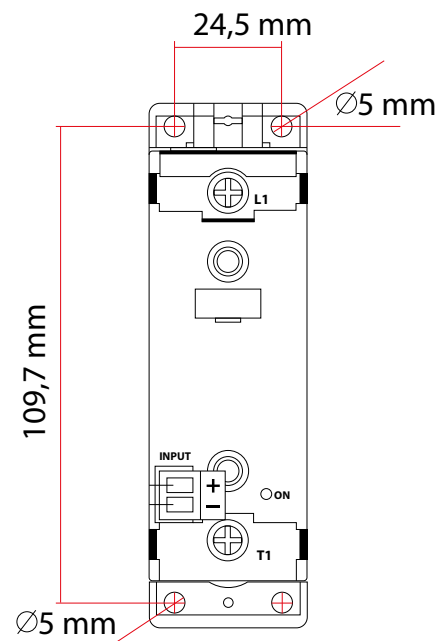

# 5 Wiring instructions

The Thyristor unit could be susceptible to interferences lost by near equipments or by the power supply, for this reason in accord to the fundamental practices rules is opportune take some precautions:

- The coil contactor, the relays and other inductive loads must be equipped with opportune RC filter.
- Use shielded bipolar cables for all the input and output signals.
- The signal cables must not be near and parallel to the power cables.
- Local regulations regarding electrical installation should be rigidly observed.

Use copper cables and wires rated for use at 90°C only.

### Power cable torque (suggested)

Type	Connector Type	Torque Lb-in (N-m)	Wire Range mm <sup>2</sup> (AWG )	MAX Current Terminals	Wire Terminals UL Listed (ZMVV)
030 035 040	Screw M5	26.6 (3.0)	1.5-10 (16-8)	50A	Rigid / Flexible Spade Terminal

### Cable dimensions of the Command Terminals

0.5 mm<sup>2</sup> (AWG 18)

### Cable dimensions of the Earth (suggested)

6 mm<sup>2</sup> (AWG 10)

Connection Diagram for Single-phase

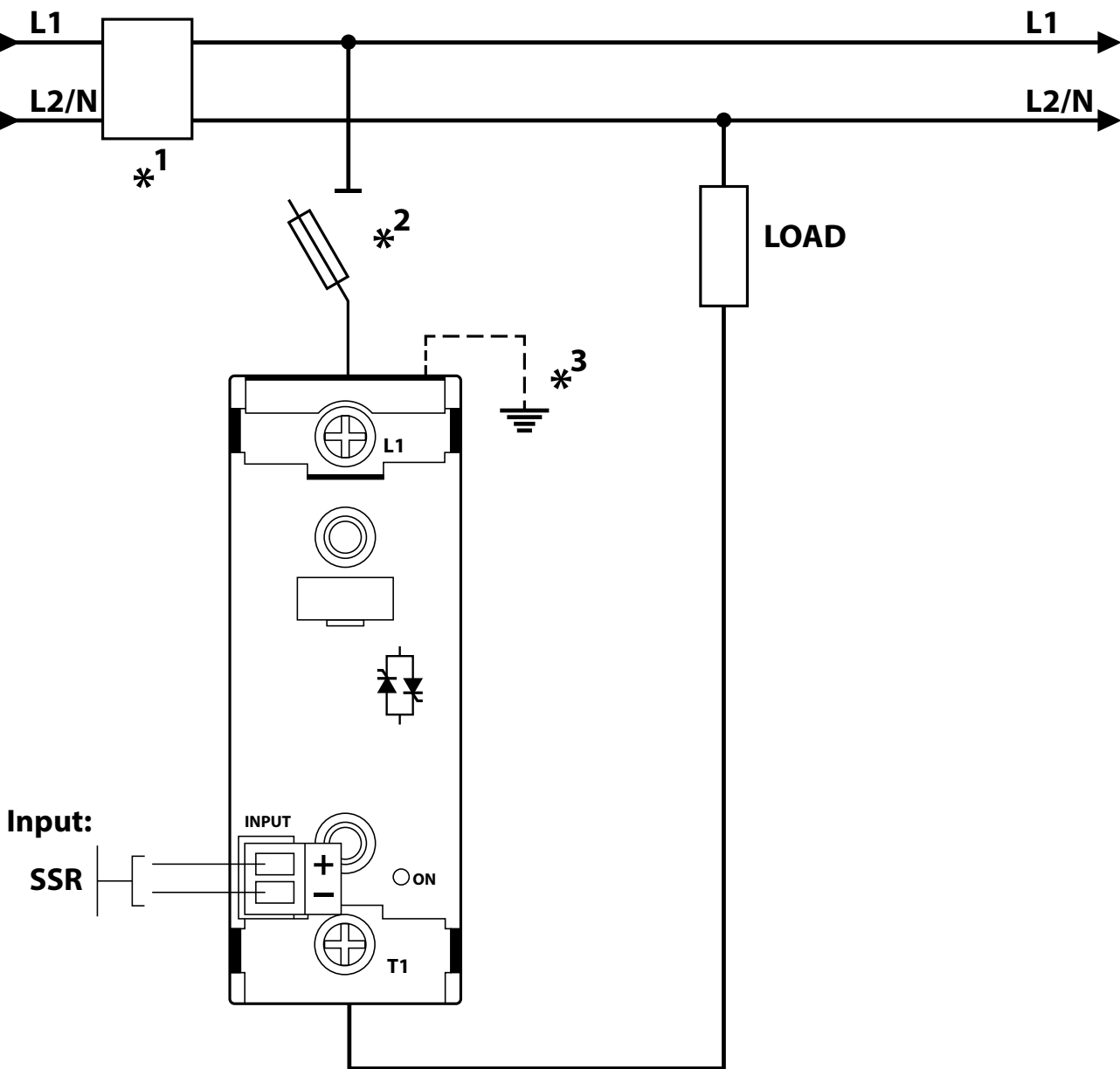

Note:

- \*1 A suitable device must ensure that the unit can be electrically isolated from the supply, this allows the qualified people to work in safety.
- \*2 The thyristor unit must be protected by extrarapid fuses (optional). The Fuses must have I<sup>2</sup>t 20% less than thyristor's I<sup>2</sup>t. The warranty of thyristor is null if no proper fuses are used (see technical data).
- \*3 The heat-sink must be connected to the earth.

# 6 Firing type

## Zero Crossing

ZC firing mode is used with Logic Output from temperature controllers and the Thyristor operates like a contactor.

The Cycle time is performed by temperature controller. ZC minimizes interferences because the Thyristor unit switches ON-OFF at zero voltage.

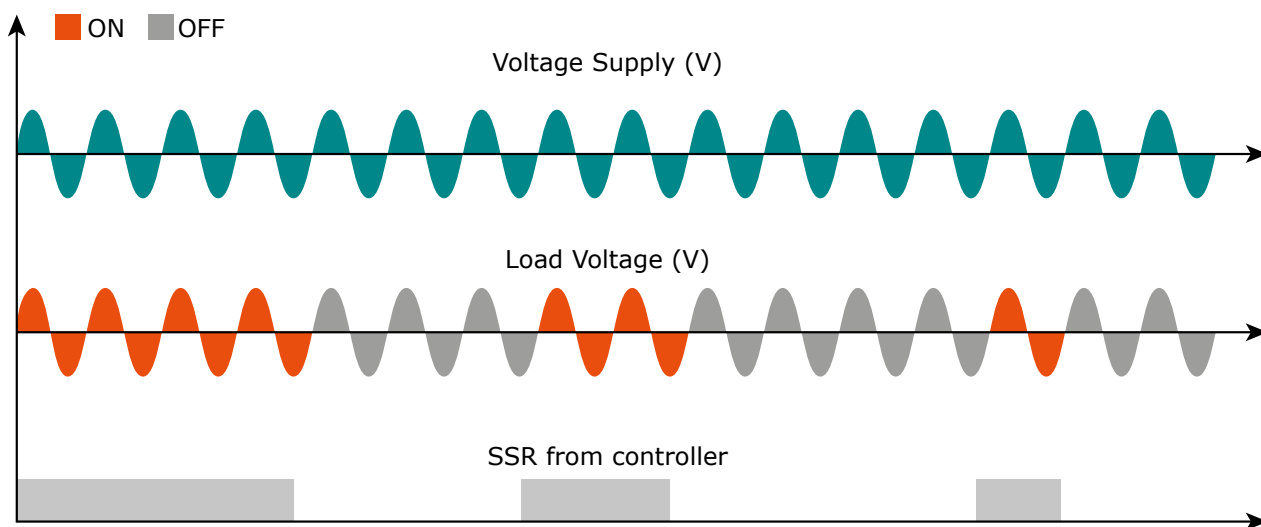

### Led status and Alarms

LED	STATUS	DESCRIPTION
ON	○	Load is NOT powered
	●	Load is powered
	○	= OFF
	●	= ON



## 7 External Fuse (not included)

The thyristor unit without IFH option (Internal Fuse + Fuse-Holder), must be protected by fuses against short circuit. The Fuses must have  $I^2t$  20% less than thyristor's  $I^2t$ . The warranty of thyristor is null if no proper fuses are used.

Type	Fuse + Fuse-Holder Order Code	Fuse Code Spare Part	Current (ARMS)	$I^2T$ at 500Vac* (A <sup>2</sup> sec.)	Vac
030	FFH1451/40A	FU1451/40A	40	525	660
035	FFH1451/50A	FU1451/50A	50	1260	660
040	FFH1451/50A	FU1451/50A	50	1260	660

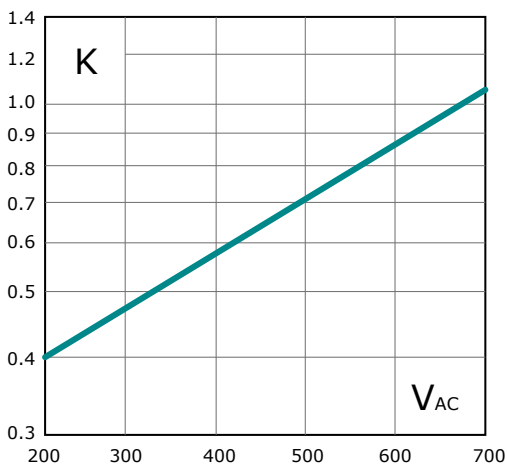

\*  $I^2T$  are multiplied for K value in function of Vac at 500V K is equal to 0,7 (750 X 0,7 = 525 1800 X 0,7 =1250).  
At 660Vsc K is equal to 1.



**Caution:** High speed fuses are used only for the thyristor protection and can not be used to protect the installation.



**Caution:** The warranty of thyristor is null if no proper fuses are used. See table.

External Fuse-holder Dimension (not included)

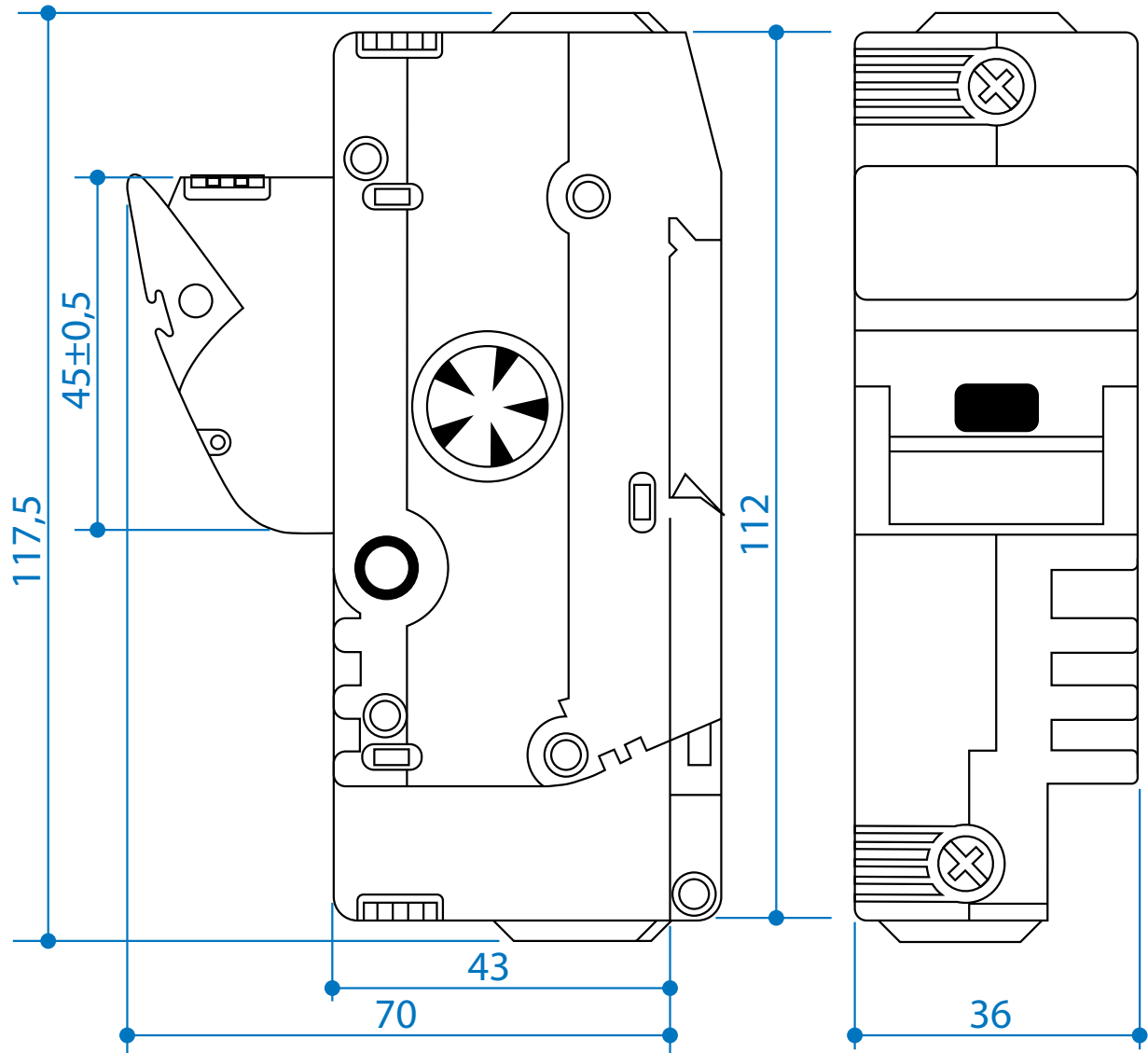

## 8

## Trouble shooting

Small problems sometimes can be solved locally with the help of the below tab of trouble shooting. If you don't succeed, contact us or your nearest distributor.

Symptom	Indication on front unit	Possible reasons of the symptom	Actions
Load current doesn't flow	Green LED (ON) light OFF	<ul style="list-style-type: none"> <li>• No input signal</li> <li>• Reversed polarities of input signal</li> </ul>	<ul style="list-style-type: none"> <li>• Give input signal</li> <li>• Reverse the input signal polarity</li> </ul>
	Green LED (ON) light ON	<ul style="list-style-type: none"> <li>• No voltage power</li> <li>• Fuse failure</li> <li>• Load failure</li> <li>• Thyristor failure</li> </ul>	<ul style="list-style-type: none"> <li>• Check the wiring</li> <li>• Change the fuse</li> <li>• Check the load</li> <li>• Change the module</li> </ul>
Load current flow also without input signal	Green LED (ON) always light OFF	<ul style="list-style-type: none"> <li>• Wrong wiring</li> <li>• SCR short circuit</li> </ul>	<ul style="list-style-type: none"> <li>• Check the wiring</li> <li>• Change the module</li> </ul>



**CD Automation S.r.l.**

Via Picasso, 34/36 - 20025 Legnano (MI)- Italy

Tel. +39 0331 577479 - Fax +39 0331 579479

E-mail: [info@cdautomation.com](mailto:info@cdautomation.com) - Web: [www.cdautomation.com](http://www.cdautomation.com)