



GENERAL DESCRIPTION

- CD3000E 3PH is a Full digital and universal Thyristor unit based on a very powerful dedicated micro configurable via serial communication port for all inputs, firing modes, control modes and loads types.
- Suitable to drive resistive, inductive, transformer and complex loads requiring current limit and power feedback.
- Internal Key Pad to control the unit and to read power, current and voltage value.
- Universal Input signal with automatic zero/span calibration.
- Universal Firing modes, customer configurable via Rs485 comm. as Burst Firing, Single Cycle and Phase Angle.
- Universal Control Mode.
- Soft Start can be used in addition to Burst Firing.
- Unbalanced load and Heater Break Alarm.
- RS 485 port. Modbus protocol.
- Internal fuses are standard on CD3000E-3PH
- Comply with EMC CE and UL
- IP20 Protection

TECHNICAL SPECIFICATION

Operating Temperature	0+40°C above this temperature see derating curve
Voltage Power supply	Range 330V to 480V, 600V on request
Auxiliary Voltage Supply	90→265V; 20VA power consumption. Fan voltage supply: 230V ±15% as a standard and 110V on request.
Analog Input 1	Primary reference, Current Input 4→20mA, 500 Ohm, Voltage Input 0→10V, 40 KOhm Potentiometer input 10K min.
Analog Input 2	External Current Limit Set, analog input to set the current limit value: 0-10V
Analog Output	n. 1 analog output 0→10V or 4→20 mA, to retransmit One of this value Current, Voltage or Power used as Control Mode
Digital Input	Four optoisolated digital input (12=24Vdc), for START, STOP, CALIBRATION and RESET ALARM
Digital Output	Two optoisolated digital output 12Vdc
Relay Output	Critical alarm
Universal Firing	One of these firing modes can be configured Burst Firing BF, Single Cycles SC, Soft Start + Burst Firing; Soft Start + Phase Angle S+PA and Delayed Triggering
Soft Start	Digital adjustable ramp rate can be used
Control Mode	Voltage (V) Current (I), Power (VxI) and External Control Mode
Heater Break Alarm	Circuit microprocessor based to diagnose partial or total load failure and short circuit on Thyristors
Unbalanced load	This protection allow to have CD3000E working up to 20% of unbalance on one of phases.
Communication	RS485 Port. Modbus communication protocol 9600 or 19200 bauds
Thermal protection	Available on forced ventilated units
Fuses	Hight speed fuses fitted internally
Mounting	Panel mounting.
Protection	IP20

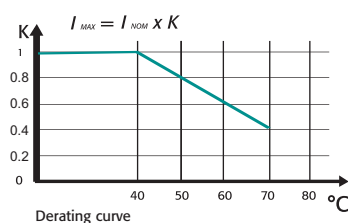

HEATER BREAK ALARM HB

ON FRONT CABINET



= FEW MINUTES TO SET AND CALIBRATE ALL THE UNITS

The Heater Break circuit diagnostic partial or total load failure. It reads load resistance with an internal voltage transducer and current transformer to calculate the resistance value V/I .

The Heater Break circuit is compensated for voltage fluctuation, in fact a voltage variation has no influence on resistance value because V/I ratio remain constant.

On this unit is possible to set the nominal resistance value and the alarm sensitivity.

HB alarm in addition diagnostic the thyristor in short circuit.

A normally open contact gives the alarm condition and an indication of the alarm type appears on display.

BURST FIRING BF

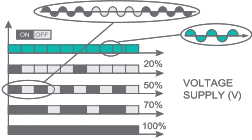

This firing is performed digitally within the thyristor unit at zero volts, producing no EMC interference. Analogue input is necessary for BF and the number of complete cycles must be specified for 50% power demand. This value can be between 1 and 255 complete cycles, determining the speed of firing. When 1 is specified, the firing mode becomes Single Cycle (SC).

PHASE ANGLE PA

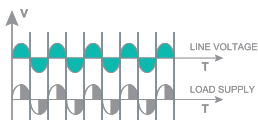

PA controls the power to the load by allowing the thyristor to conduct for part of the AC supply cycle only. The more power required, the more the conduction angle is advanced until virtually the whole cycle is conducting for 100% power. The load power can be adjusted from 0 to 100% as a function of the analogue input signal, normally determined by a temperature controller or potentiometer, PA is normally used with inductive loads.

DELAYED TRIGGERING DT

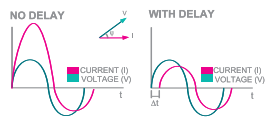

Used to switch the primary coil of transformers when coupled with normal resistive loads (not cold resistance) on the secondary, DT prevents the inrush current when zero voltage (ON-OFF) is used to switch the primary. The thyristor unit switches OFF when the load voltage is negative and switches ON only when positive with a pre-set delay for the first half cycle.

CD EASY



This is a memory support tool that can be used by maintenance personnel on shop floor.

The user can copy the configuration of one unit and paste it into another. CD EASY is very simple with one push button to upload the configuration (Read) and another to download the stored configuration (Write)

This tool can be used with our Remote service to mail the working configuration via internet.

FIELD BUS MODULE



CD-RS Used to convert RS232 to RS422

TU-RS485-PDP Used to convert RS485 Modbus to Profibus DP

TU-RS485-ETH Used to convert RS485 Modbus to Ethernet

For more informations see "Field Bus Module"

POWER SCALING

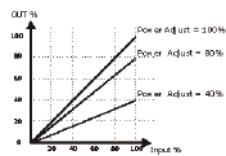

It's a scaling factor of the input command signal and limit the output of Thyristor unit. This parameter can be adjusted from 1 to 99% via RS485 or by the front of the unit. If this parameter is setted at 50% and the input signal is 100% the output become 50%. This feature is very useful to reduce the power when a zone has been oversized or when a temperature controller gives same reference to more unit along a furnace.

Imagine 3 zones with left and right one close to the door where in a continuous furnace the material come into and flow out. The profile of temperature along furnace is higher in central zone because there is less dispersion but if we scale its input we can have a flat profile.

APPLICATIONS AND FOCUS ON:

- Infrared lamp.
- Autoclaves.
- Fournaces.
- Chemical
- Petrochemical
- Climatic chambers
- Pharmaceutical

WIRING CONNECTION REVO CD3000E up to 500A

CD3000E Size S09

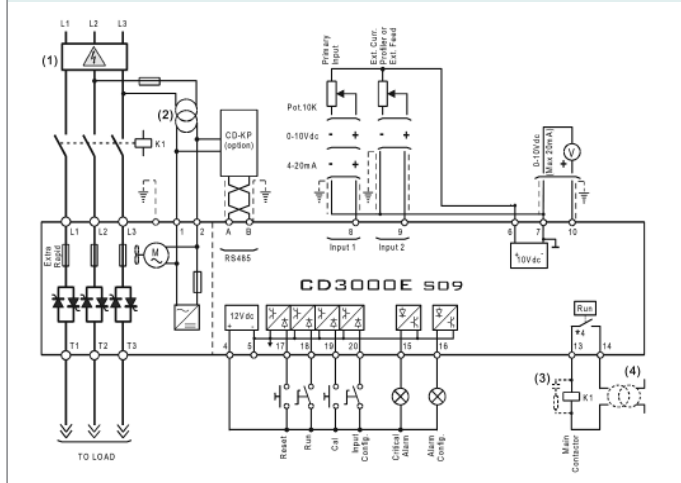

CD3000E Size s14

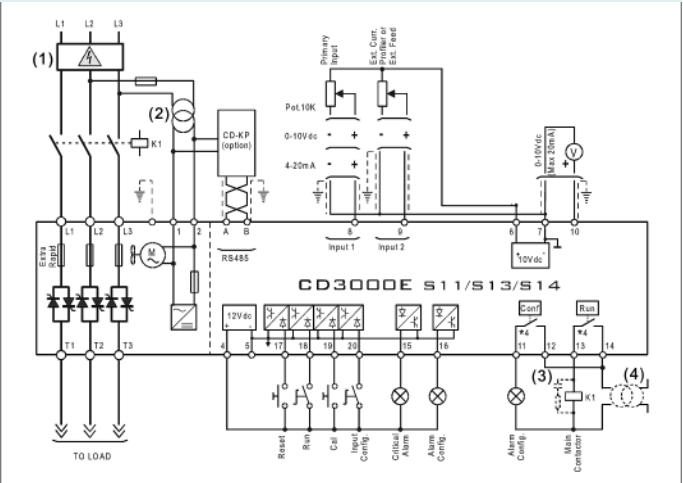

LOAD TYPE

Three phase transformer
Cold Resistance
Molibdenum, Tungstenum
KantalSuper Platinum,
Quartz lamp infrared short wave-
form
Silicon carbide elements

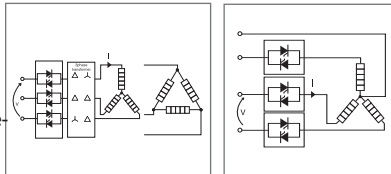

NOTE

- The user installation must be protected by electromagnetic circuit breaker or by fuse isolator.
- Use an appropriate external transformer to supply the electronic board (see the identification label)
- The coil contactor, the relays and other inductive loads must be equipped with appropriate RG filter.
- Before to activate the Start command the electronic board must be energized.

SIZE S09 25÷75A

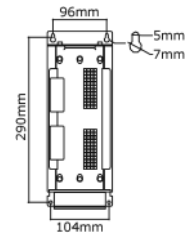
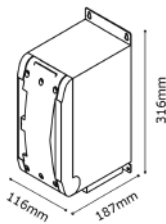

SIZE S11 100÷150A

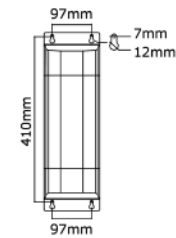
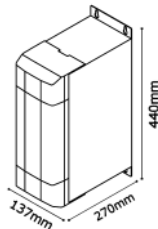

SIZE S13 280A

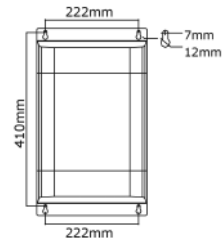
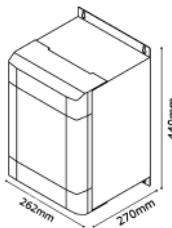

SIZE S14 300÷500A

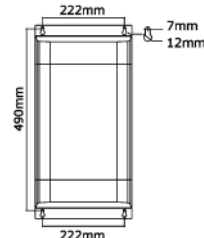
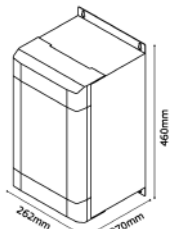

OUTPUT FEATURES (POWER DEVICE)

Current A	Voltage range (V)	Ripetitive peak reverse voltage (480V) (600V)		Latching current (mAeff)	Max peak one cycle (10msec.)	Leakage current	I2T value for fusing tp=10msec.	Frequency range (Hz)	Power loss I=Inom (W)	Isolation Voltage Vac
25A	330÷600V	1600	1600	450	500	15	1030	47÷70	90	2500
35A	330÷600V	1600	1600	450	1000	15	4750	47÷70	126	2500
45A	330÷600V	1600	1600	450	1000	15	4810	47÷70	162	2500
75A	330÷600V	1600	1600	450	1000	15	4810	47÷70	270	2500
100A	330÷600V	1600	1600	450	1540	15	11300	47÷70	360	2500
125A	330÷600V	1600	1600	450	2000	15	19100	47÷70	450	2500
150A	330÷600V	1600	1600	450	2000	15	19100	47÷70	540	2500
255A	330÷600V	1600	1600	300	4800	15	108000	47÷70	810	2500
300A	330÷600V	1600	1600	300	5250	15	128000	47÷70	1080	2500
350A	330÷600V	1600	1600	200	7800	15	300000	47÷70	1260	2500
400A	330÷600V	1600	1600	200	8000	15	306000	47÷70	1440	2500
450A	330÷600V	1600	1600	1000	17800	15	1027000	47÷70	1620	2500
500A	330÷600V	1600	1600	1000	17800	15	1027000	47÷70	1800	2500

ORDERING CODES CD3000E 3PH

	1	2	3	4	5	6	7	8	9	10	11	12	13	14	15	16	Note 1
CD3000E 3PH	R	E	3	-	-	-	-	-	-	-	-	-	-	-	-	-	

4, 5, 6 Current		9 Input		12 Option		16 Load type/Connection	
Description code	Numeric code	Description code	Numeric code	Description code	Numeric code	Description code	Numeric code
35A	0 3 5	SSR 3:30V dc	S	Control Mode Retransmission 4:20mA	A	Resistive Load/Delta Connection	1
45A	0 4 5	0:10V	V	Control Mode Retransmission 0:10V	V	Resistive Load/Star Connection	2
75A	0 7 5	4:20mA	A	13 Fan Voltage		Resistive Load/Star Connection + Neutral	7
100A	1 0 0	10KPot	K	Description code	Numeric code	Transformer Load/Delta Connection	3
125A	1 2 5	RS485	R	Fan Voltage equal to Aux. Voltage	3	Transformer Load/Star Connection	4
150A	1 5 0	10 Firing		14 Approvals		Transformer Load/Star Connection + Neutral	5
225A	2 2 5	Description code	Numeric code	CE EMC For European Market	0	Resistive Load/Open delta	6
300A	3 0 0	Zero Crossing ZC	Z	cUL For American Market (Pending)	L		
350A	3 5 0	Single Cycle SC	C	15 Manual			
400A	4 0 0	Burst Firing BF	B	Description code	Numeric code		
450A	4 5 0	Soft Start + Burst Firing S+BF	J	None	0		
500A	5 0 0	Delayed Triggering + Burst Firing DT+BF	D (2)	Italian Manual	1		
		Phase Angle PA	P	English Manual	2		
		Soft Start + Phase Angle S+PA	E	German Manual	3		
		11 Control Mode		French Manual	4		
		Description code	Numeric code				
		Open Loop	0				
		Voltage Feedback V	U				
		Power Feedback VxI	W				
		Current Feedback I	I				

LEGEND
IF = Internal Fixed Fuse
CT = Current Transformer
HB = Heater Break Alarm

Note (1): After 16th digit write current and voltage of load inside brackets Ex. (190A-400V). Required if units are to be tuned to load.
Note (2): DT+BF can be used to drive transformers coupled with normal resistance



CD Automation UK Ltd

Tel: +44 (0)1323 811100
 Email: info@cdautomation.co.uk
 Web: www.cdautomation.co.uk/CD3000E