



GENERAL DESCRIPTION

- Revo M has been specifically designed to be an Universal Unit
- RS485 Comm. MODBUS Protocol Standard
- Frontal Key Pad to configure the unit and to read V,I and Power
- Configurability via RS485, USB Port and frontal Key Pad
- Microprocessor based electronic circuit fully isolated from power
- Universal input signal: RS485,Pot, Analog and SSR
- Universal Firing Mode: Soft Start + Phase Angle, Delayed Triggering Firing, Single Cycle, Burst Firing
- Configurable Control Mode: V, I, V² and VxI
- Heater Break alarm to diagnose partial or total load failure and Thyristor Short circuit
- Digital input configurable
- Fixed Fuses Standard
- Current transformer integrated in the unit
- Comply with EMC, cUL pending
- IP20 Protection
- Panel mounting

TECHNICAL SPECIFICATION

Voltage power supply	From 24V to 480V Max (Std) or 600V on request		
Voltage Frequency	50 or 60 Hz no setting needed from 47 to 70 Hz		
Nominal Current	60A, 90A, 120A, 150A, 180A, 210A		
Input Signal	SSR (logic)	4:30Vdc	5mA Max (On ≥ 4Vdc Off ≤ 1Vdc);
	Voltage input	0:10Vdc	impedance 15 K ohm;
	Current input	0:20/4:20mA	impedance 100 Ohm;
Digital input	4:30V dc 5 mA Max (On > 4Vdc Off < 1Vdc)		
Firing	Soft Start + Phase Angle, Delay Triggering + Burst Firing, Soft Start + Burst Firing, Single Cycle, Selectable from frontal Key-Pad or via RS485.		
Control Mode	Voltage, Current, Square Voltage and Power selectable via frontal Key Pad, and RS485 or via Digital input to transfer from one control mode to another one to establish a control strategy.		
Auxiliary Voltage Supply	90:130Vac	8VA Max	
	170:265Vac	8VA Max	(Standard)
	230:345Vac	8VA Max	
	300:530Vac	8VA Max	(Standard)
	510:690Vac	8VA Max	
Fan Voltage Supply	230V Std and 110V on request		
Heater Break Alarm	HB alarm setting on front unit or RS485 with possibility to set sensitivity. Relay output 0,5A at 110V		
Mounting	Panel Mounting		
Operating Temperature	40 °C without derating. Over this temperature see below derating curve		
Storage temperature	-25 °C to 70 °C Max		
Altitude	Over 1000 m of altitude reduce the nominal current of 2% for each 100m		
Humidity	From 5 to 95% without condense and ice		

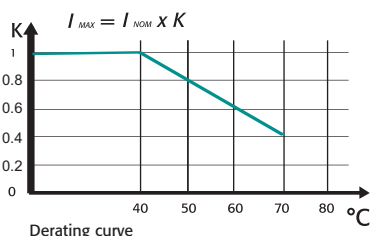

OPTION'S FEATURES AND SPECIAL DETAILS

HEATER BREAK ALARM HB

ON FRONT CABINET



FEW SECOND TO SET AND CALIBRATE ALL THE UNITS

- Microprocessor based circuit
- Capacity to diagnose the failure of one Resistance over five in parallel
- Load failure alarm with LED indication on front unit
- Thyristor short circuit alarm with LED indication on front unit
- Alarm output with free voltage relay contact
- Alarm reset function and possibility to auto reset if the alarm disappear
- Built in Current transformer when heather Break option has been selected
- Self Setting via external command or push button on front unit
- Common setting command can be given to many units and in a matter of second, the tuning is done, also by a non expert operator

BURST FIRING BF

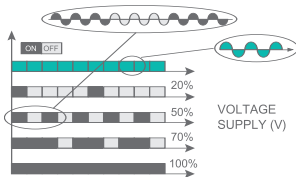

This firing is performed digitally within the thyristor unit at zero volts, producing no EMC interference. Analogue input is necessary for BF and the number of complete cycles must be specified for 50% power demand. This value can be between 1 and 255 complete cycles, determining the speed of firing. When 1 is specified, the firing mode becomes Single Cycle (SC).

PHASE ANGLE PA

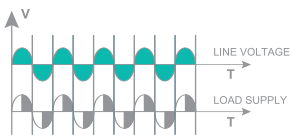

PA controls the power to the load by allowing the thyristor to conduct for part of the AC supply cycle only. The more power required, the more the conduction angle is advanced until virtually the whole cycle is conducting for 100% power. The load power can be adjusted from 0 to 100% as a function of the analogue input signal, normally determined by a temperature controller or potentiometer, PA is normally used with inductive loads.

DELAYED TRIGGERING DT

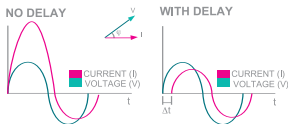

Used to switch the primary coil of transformers when coupled with normal resistive loads (not cold resistance) on the secondary, DT prevents the inrush current when zero voltage (ON-OFF) is used to switch the primary. The thyristor unit switches OFF when the load voltage is negative and switches ON only when positive with a pre-set delay for the first half cycle.

FIELD BUS MODULE



CD-RS Used to convert RS232 to RS422
 TU-RS485-PDP Used to convert RS485 Modbus to Profibus DP
 TU-RS485-ETH Used to convert RS485 Modbus to Ethernet
 For more informations see "Field Bus Module" Bulletin

POWER SCALING

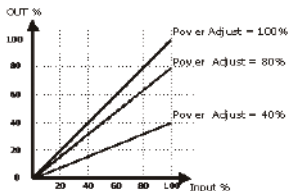

It's a scaling factor of the input command signal and limit the output of Thyristor unit. This parameter can be adjusted from 1 to 99% via RS485 or by the front of the unit. If this parameter is set at 50% and the input signal is 100% the output become 50%. This feature is very useful to reduce the power when a zone has been oversized or when a temperature controller gives same reference to more unit along a furnace. Imagine 3 zones with left and right one close to the door where in a continuous furnace the material come into and flow out. The profile of temperature along furnace is higher in central zone because there is less dispersion but if we scale its input we can have a flat profile.

APPLICATIONS AND FOCUS ON:

- Infra red lamp.
- Autoclaves.
- Furnaces.
- Dryers.
- Climatic chambers

WIRING CONNECTION REVO M 1PH from 60A to 210A

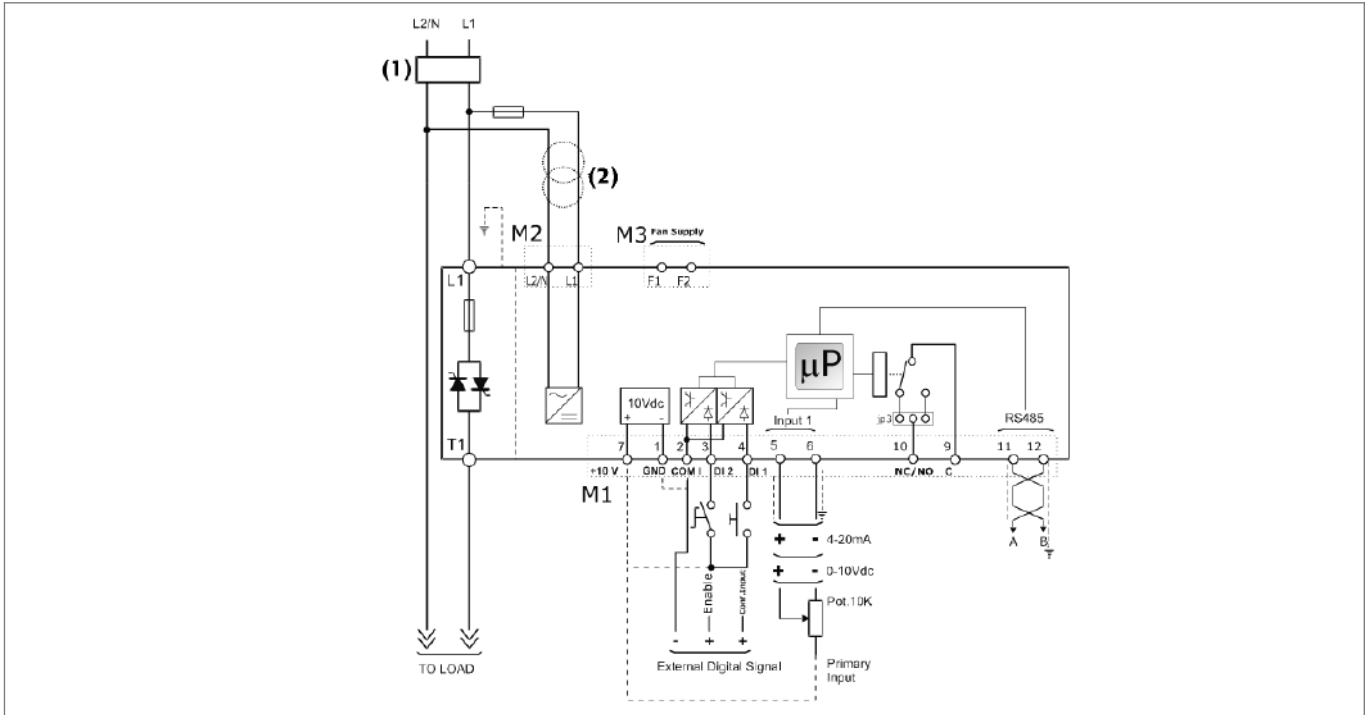

LOAD TYPE

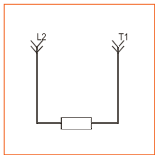

Resistance and Infrared Lamps Long and medium waves

LOAD TYPE

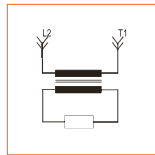

Use Delayed Triggering for transformers coupled with Normal resistance

NOTE

- The user installation must be protecting by electromagnetic circuit breaker or by fuse isolator. The semiconductor I^2t should be 20% less than power controller I^2t . Semiconductor fuses are classified for UL as supplementar protection for semiconductor. They are note approved for branch circuit protection.
- The auxiliary voltage supply of the Revo M unit must be synchronized with loadvoltage power supply. If the Auxiliary Voltage (written on the identification label) is different from Supply Voltage (to the load), use an external transformer connected as above.

DIMENSION AND FIXING HOLES

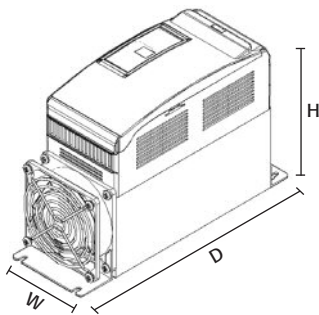

SR15 W 93 mm. - H 273 mm. - D 170 mm. - kg. 3,6

120A ÷ 210A

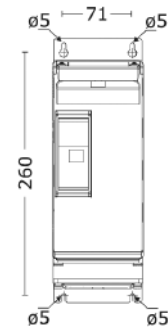

120A ÷ 210A

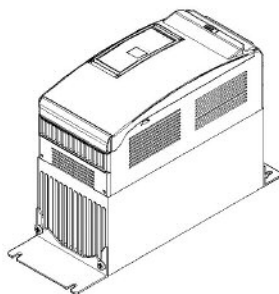

SR15 W 93 mm. - H 269 mm. - D 170 mm. - kg. 3,6

60A ÷ 90A

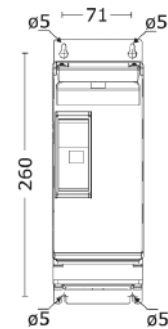

60A ÷ 90A

OUTPUT FEATURES (POWER DEVICE)

Current A	Voltage range (V)	Ripetitive peak reverse voltage (480V) (600V)		Latching current (mAeff)	Max peak one cycle (10msec.)	Leakage current (mAeff)	I2T value for fusing tp=10msec.	Frequency range (Hz)	Power loss I=Inom (W)	Isolation Voltage Vac
60A	24+600V	1200	1600	450	1000	15	4750	47+70	65	2500
90A	24+600V	1200	1600	450	2000	15	19100	47+70	84	2500
120A	24+600V	1200	1600	450	1540	15	11300	47+70	138	2500
150A	24+600V	1200	1600	450	2000	15	19100	47+70	162	2500
180A	24+600V	1200	1600	300	4800	15	108000	47+70	178	2500
210A	24+600V	1200	1600	300	5250	15	128000	47+70	202	2500

Fan Specification

Supply: 230V Standard (need for REVO M > 90A)

Power 16W

Supply: 115V Option (need for REVO M > 90A)

Power 14W

ORDERING CODES REVOM 1PH

																Note 1
REVO M 1PH																16
1	2	3	4	5	6	7	8	9	10	11	12	13	14	15	16	
R	M	1	-	-	-	-	-	-	-	-	-	-	-	-	-	
4, 5, 6 Current		8 Aux. Voltage supply		11 Control Mode		14 Approvals										
Description code	Numeric code	Description code	Numeric code	Description code	Numeric code	Description code	Numeric code									
60A	0 6 0	90:130V (2)	1	Open Loop	0	CE EMC For European Market	0									
90A	0 9 0	170:265V (2)	2	Voltage Feed Back V	U	cUL For American Market, Pending	L									
120A	1 2 0	230:345V (2)	3	Power Feed Back VxI	W	15 Manual										
150A	1 5 0	300:530V (2)	5	Voltage Square f/b V ²	Q	Description code	Numeric code									
180A	1 8 0	510:690V (2)	6	Current Feed Back I	I	None	0									
210A	2 1 0	9 Input		Voltage to Power Feedback Transfer	T	Italian Manual	1									
7 Max Voltage		Description code	Numeric code	12 Fuse & Option		English Manual	2									
Description code	Numeric code	SSR	S	Description code	Numeric code	German Manual	3									
480V	4	0:10V dc	V	Fixed Fuses +CT	Y	French Manual	4									
600V	6	4:20mA	A	Fixed Fuses +CT+HB	H	16 Version										
		10KPot	K	Control Mode Retransmission 0:40mA	A	Description code	Numeric code									
		RS485	R	Control Mode Retransmission 0:10V	V	Std with fixed Fuses	1									
		10 Firing		13 Fan Voltage												
Description code	Numeric code	Description code	Numeric code	Description code	Numeric code											
Zero Crossing ZC	Z	Soft Start + Burst Firing S+BF	J	No Fan ≤ 90A	0											
Single Cycle SC	C	Delayed Triggering + Burst Firing DT+BF	D	Fan 110V > 90A	1											
Burst Firing BF	B	Phase Angle PA	P	Fan 220V > 90A Std Version	2											
Soft Start + Burst Firing S+BF	J	Soft Start + Phase Angle S+PA	E													

LEGEND

CT = Current Transformer

HB = Heater Break Alarm

Note (1): After 16th digit write current and voltage of load inside brackets Ex. (40A-400V)
 Note (2): Load voltage must be included in Selected Auxiliary Voltage Range



CD Automation

Tel: +44 (0)1323 811-100

Email: info@cdautomation.co.uk

Web: www.cdautomation.co.uk/revo-m-1ph