

MULTIDRIVE-2PH THYRISTOR UNIT

00009

from 45A to 850A



CD Automation UK Ltd

Product Support:

Tel: +44 1323 811100 Email: info@cdautomation.co.uk

SUMMARY

1 Important warnings for safety	5
2 Introduction	7
2.1 Advantages compared with analog thyristor unit	7
2.2 CD-KP	8
2.3 CD-EASY	8
2.4 Software Configurator	9
3 Quick Start	10
4 MULTIDRIVE Sizing	11
5 Identification and Order Code	12
5.1 Identification of the unit	12
5.2 Order Code	13
6 Installation.....	14
6.1 Environmental installation conditions	14
6.2 Dimensions and Weight	15
6.3 Fixing holes	16
7 Wiring instructions.....	17
7.1 Removing the cover	17
7.2 Wiring details	17
7.3 Power Terminals	19
7.4 Command Terminals	20
7.5 Diagram of control connection	21
8 Power output features	22
8.1 Derating curve	22
8.2 Cooling fans	22
9 Led status and Alarms.....	23
9.1 LED Status Table	23
9.2 Critical Alarms	24
9.3 Not Critical Alarm	25
9.4 Calibration Procedure	25
10 Control Panel.....	26
10.1 Scroll the parameters	27

11 Firing type	28
11.1 Burst Firing (BF)	28
11.2 Delay Triggering (DT)	30
11.3 Action of the Limit Current	32
11.4 Feed-back type	33
12 Connection description	34
12.1 Access to the Electronic boards	34
12.2 Supply the Electronic Board PWI30	35
12.3 External Feed-Back	35
12.4 Analog Inputs	36
12.5 Analog Outputs	38
12.6 Digital Input	40
12.7 Digital Output	41
12.8 PG Connector	44
12.9 RS485 Serial Port	45
12.10 Fuse Board protection	46
13 MODBUS communication	48
13.1 MODBUS RTU Protocol	48
13.2 Message Format	48
13.3 Read Holding Registers	51
13.4 Preset Multiple Registers	51
13.5 Error and exception responses	52
13.6 Address Configuration	52
14 Configuration Parameters	53
14.1 Operator Menu	53
14.2 Hardware Menu	55
14.3 Setup Menu	58
15 Internal Fuse.....	59
15.1 Fuse Code	59
16 Maintenance.....	60
16.1 Fans	60
16.2 Maintenance	60
16.3 Repairing procedure	60
16.4 Warranty condition	60

1 Important warnings for safety

This chapter contains important information for the safety. The not observance of these instructions may result in serious personal injury or death and can cause serious damages to the Thyristor unit and to the components system included.

The installation should be performed by qualified persons.



The Thyristor unit are integral part of industrial equipments. When it is supply, the Thyristor unit is subject to dangerous tensions.

- Don't remove the protection Cover.
- Don't use these unit in aerospace applications and/ or nuclear.



The nominal current corresponds to use at temperature not superior to 45°C.

- The Thyristor unit must be mounted in vertical position and without obstruction above and below to allow a good flow ventilation.
- The hot air of one thyristor unit must not invest the unit positioned above.
- For side by side placed leave a space of 15mm between the unit.



A suitable device must ensure that the unit can be electrically isolated from the supply, this allows the qualified people to work in safety.



Protection (Protection, Protezione)

The unit have IP20 protection rating as defined by the specific international. Is necessary consider the place of installation.



Earth (Terre, Messa a terra)

For safety, the Thyristor unit with isolated heat-sink must be connected to earth.

Earth impedance should be correspondent to local earth regulation. Periodically the earth efficiency should be inspected.



Electronic supply (Alimentation électronique, Alimentazione elettronica)

The electronic circuit of the Thyristor unit must be supplied by dedicated voltage for all electronic circuits and not in parallel with coil contactors, solenoids and other.

It's recommended to use a shielded transformer.



Electric Shock Hazard (Risque de choc électrique, Rischi di scosse elettriche)

When the Thyristor unit is energized, after the power supply is shut off, wait least a minute for allow the discharge of the internal capacitors where there is a dangerous tension. Before working, make sure that:

- Only authorized personnel must perform maintenance, inspection, and replacement operations.
- The authorized personnel must read this manual before to have access to the unit.
- Unqualified People don't perform jobs on the same unit or in the immediate vicinities.

**Important warnings (Attention, Avvertenze importanti)**

During the operations with units under tension, local regulations regarding electrical installation should be rigidly observed:

- Respect the internal safety rules.
- Don't bend components to maintain insulation distances.
- Protect the units from high temperature humidity and vibrations.
- Don't touch components to prevent electrostatic discharges on them.
- Verify that the size is in line with real needs.
- To measure voltage current etc. on unit, remove rings and other jewels from fingers and hands.
- Authorized personnel that work on thyristor unit under power supply voltage must be on insulated board

This listing does not represent a complete enumeration of all necessary safety cautions.

**Electromagnetic compatibility****(Compatibilità elettromagnetica, Compatibilità elettromagnetica)**

Our thyristor units have an excellent immunity to electromagnetic interferences if all suggestions contained in this manual are respected. In respect to a good Engineering practice, all inductive loads like solenoids contactor coils should have a filter in parallel.

**Emissions (Emission, Emissioni)**

All solid-state power controllers emit a certain amount of radio-frequency energy because of the fast switching of the power devices.

The CD Automation's Thyristor unit are in accord with the EMC norms, CE mark.

In most installations, near by electronic systems will experience no difficulty with interference. If very sensitive electronic measuring equipment or low-frequency radio receivers are to be used near the unit, some special precautions may be required. These may include the installation of a line supply filter and the use of screened (shielded) output cable to the load.

Note

Warning: This icon is present in all the operational procedures where the Improper operation may result in serious personal injury or death



Caution: This icon is present in all the operational procedures where the Improper operation can cause damage for the Thyristor unit.

CD Automation reserves the right to modify the own products and this manual without any advise.



2 Introduction

A thyristor unit is semiconductor device which acts as a switch formed by two thyristors in ant parallel. To switch on the alternating current the input signal will be on and the thyristor will switch off at first Zero Crossing voltage with no input signal.

The benefits of thyristor units compared with elettromechanical contactors are numerous: no moving parts, no maintenance and capacity to switch very fast. Thyristors are the only solution to control transformers and special loads that change resistance with temperature and with age.

2.1 Advantages compared with analog thyristor unit

MULTIDRIVE is an universal Thyristor unit, designed to control resistive or inductive loads including three phase transformers. The electronic circuit is completely digital and is based on a powerful microprocessor with high performance that allow the use in different ways:

- Single cycle (Not used for 2PH version)
- Burst Firing
- Delayed triggering
- Phase Angle (Not used for 2PH version)

On same unit can be used different feed back that define the control mode:

- Voltage
- Current
- Power $V \times I$
- External $0 \div 10Vdc$

On same unit can be used different input:

- $4 \div 20mA$
- $0 \div 10Vdc$
- Potentiometer $10K\Omega$
- SSR

Communication RS485 is a standard feature of MULTIDRIVE this allows the use of many information like: tension, current, power, load state and all the parameters for diagnostic and configuration. Ulterior advantages of the digital system vs the analogical is the flexibility and the possibility of implement special characteristics without change the hardware. Several strategies can be implemented and selected through the configuration parameters.

With CD-KP, you can have access to the configuration parameters without expose at the dangerous voltaqe inside the cabinet and without stop the plant.

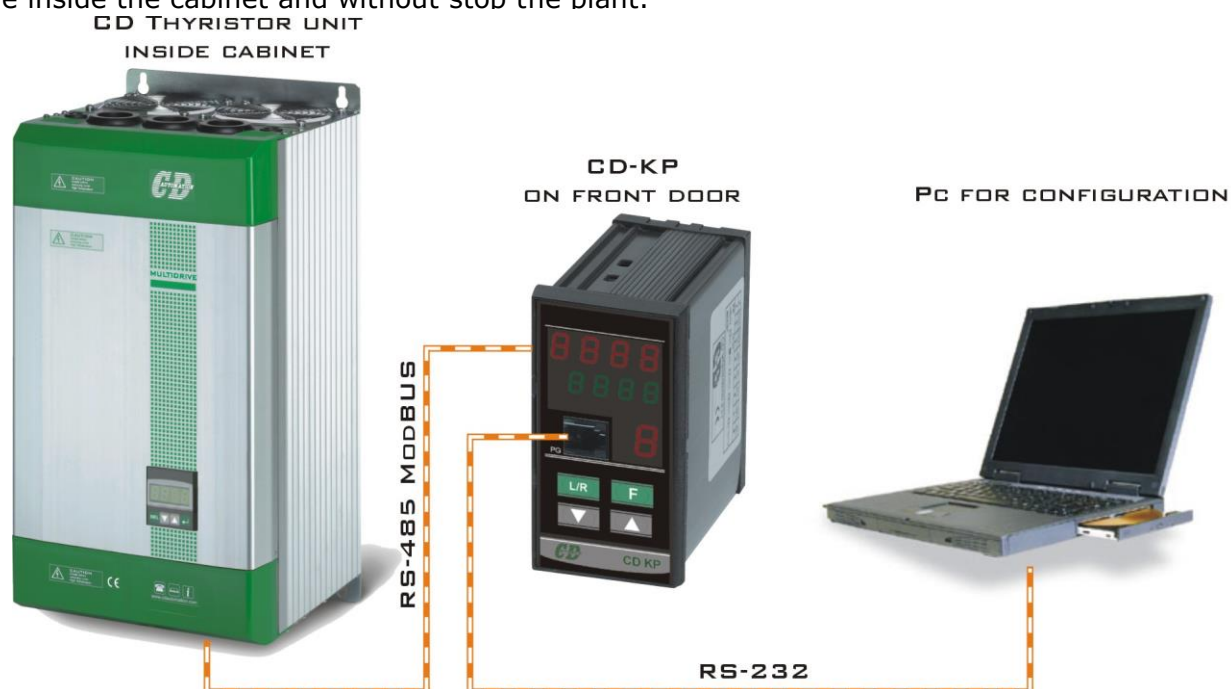

2.2 CD-KP

The CD-KP is designed to be connected with all CD Automation's Thyristor units via RS485 communication. On front unit is possible to read the principal operational parameters of the unit like: power, tension, current, reference, alarms, etc.

One of these variables can be selected and retransmitted via an isolated output (4÷20mA or 0÷10V) All the menus (except the operator menu) can be protected by password to avoid accidental change of configuration parameters by unauthorised personnel.

On front unit is also available a plug-in connector RS485 for connect a PC with the Thyristor units without open the cabinet and without stop the production process.

Technical Specification:

- Use in Local/Remote
- Set Point Ramp UP - Down
- Scroll selection of:
 - Set point
 - Power output
 - Current
 - Voltage
- Display indication for:
 - Heater Break alarm
 - SCR short circuit
- Password for configuration parameters
- Plug-in connector on front to use software configurator
- Retransmission (4-20mA or 0-10Vdc) of one of these parameters: Power PV, Current, Voltage.
- Dimension 48x96x92mm (LxAxP)
- Comply with EMC, CE marked



2.3 CD-EASY

CD-EASY is a Memory of support used for maintenance people that is not confident in personal computer.

With the CD-EASY is possible memorize the configuration of one Thyristor Unit and paste it into another in few seconds.

CD-EASY could be loaded with the personal configuration of the unit and stored together with the system drawings in a convenient place, enabling unit reconfiguration within seconds if require.

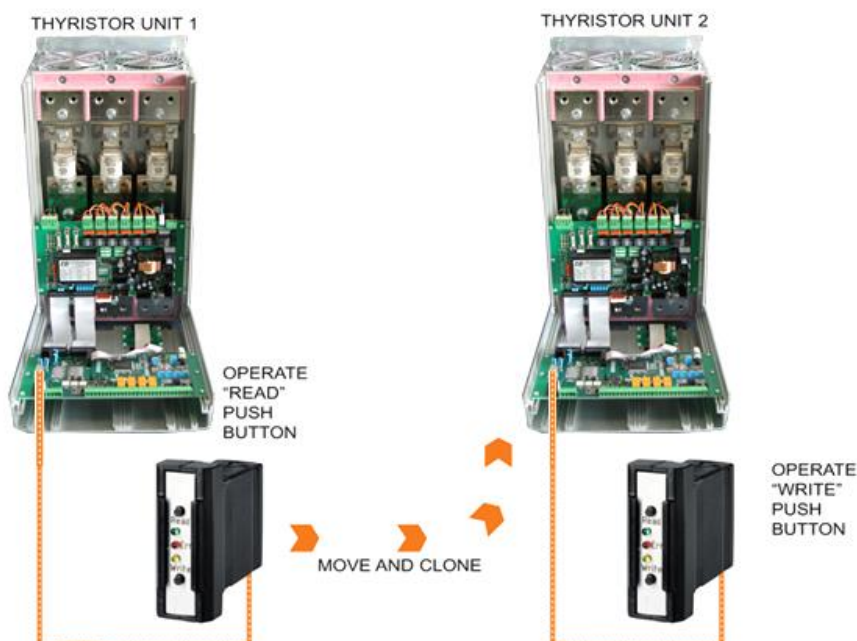

2.4 Software Configurator

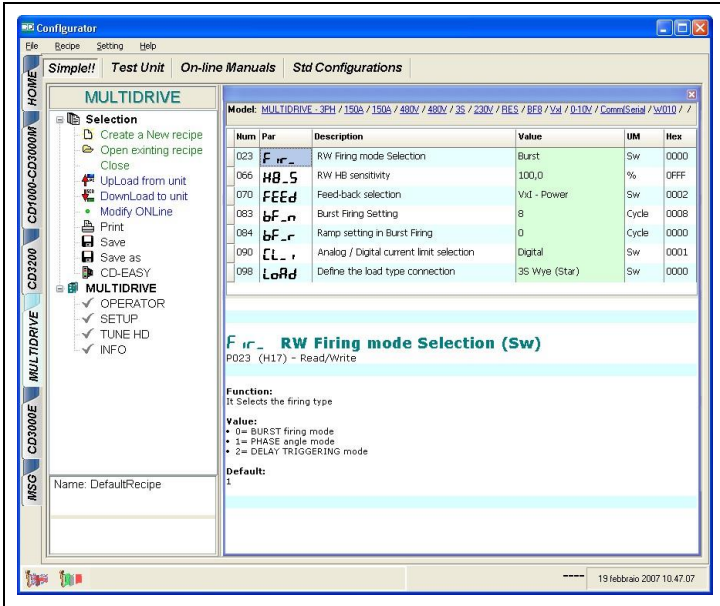

The software configuration is free and is possible download it from our site: www.cdautomation.com

If the Order Code is in line with requirement, then MULTIDRIVE has been already configured in Factory and it's ready to use. You need the software only to modify the ordered configuration. Anyway we suggest to check the unit on the machine with the "Test unit" section.

For install the software, launch the program and follow the instructions on the screen.



To connect the unit at the PC, it's necessary use the programming cable connected between the PG connector (see par. 12.8) and the serial port RS232 of the PC.

The programming cable is not included.



With the CD-RS serial converter is possible configure the Thyristor unit also through the RS485 (see par. 12.9). For this solution, the programming cable is not necessary.

Run the software configurator and set the serial port of the PC like the parameters P114 *boud* and P115 *Addr* of the Thyristor unit.

3 Quick Start



Caution: *this procedure must be performed only by qualified persons.*

If the Order Code of the Thyristor unit is in line with what you really need, then MULTIDRIVE has been already configured in Factory and you just need to do the following steps:

1. Verify the MULTIDRIVE Sizing. Making sure that:
 - The load current is equal or less than the MAX current of MULTIDRIVE.
 - The load voltage is equal or less than the MAX voltage of MULTIDRIVE.(see par. 4)
2. Verify the Order Code
(see par. 5.2)
3. Verify the Installation
(see par. 6)
4. Verify the Diagram of control connection:
 - All auxiliary connections must be done in line with wirings on this manual.
 - Verify that there isn't a short circuit on the load.(see par. 7.5)
5. Supply the Electronic boards
(see Order Code)
6. If not specified in the Order Code:
 - Set the Load Voltage in the parameter P116 U_{OP}.
 - Set the Load Current in the parameter P119 R_{Lo}.(see par. 14.1)
7. With Burst Firing (BF) or Heater Break Alarm (HB)
make the Calibration procedure
(see par. 9.4)

The MULTIDRIVE Thyristor unit is ready to start.

4 MULTIDRIVE Sizing

4.1.1 Star wiring with resistive load

$$I = \frac{P}{1,73V}$$

V = Nominal voltage phase to phase

I = Nominal current of the load

P = Nominal power of the load

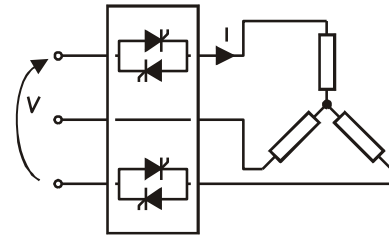

4.1.2 Star wiring with inductive load

$$I = \frac{P}{1,73V \cos \phi}$$

V = Nominal voltage phase to phase

I = Nominal current of the load

P = Nominal power of the load

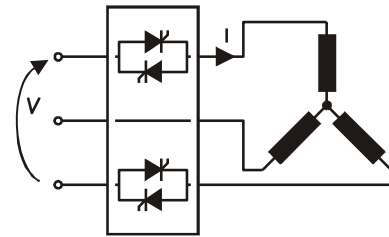

4.1.3 Delta wiring with resistive load

$$I = \frac{P}{1,73V}$$

V = Nominal voltage phase to phase

I = Nominal current of the load

P = Nominal power of the load

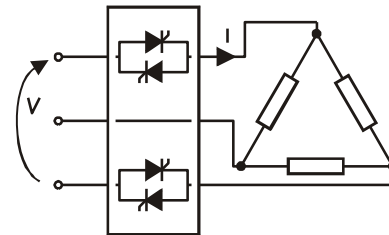

4.1.4 Delta wiring with inductive load

$$I = \frac{P}{1,73V \cos \phi}$$

V = Nominal voltage phase to phase

I = Nominal current of the load

P = Nominal power of the load

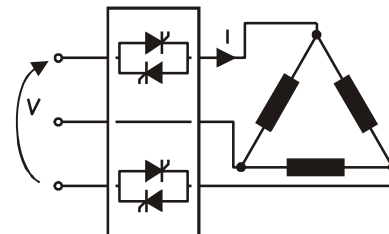

5 Identification and Order Code

5.1 Identification of the unit



Caution: Before to install, make sure that the Thyristor unit have not damages. If the product has a fault, please contact the dealer from which you purchased the product.

The identification's label give all the information regarding the factory settings of the Thyristor unit, this label is on the unit, like represented in figure.

Verify that the product is the same thing as ordered (see par. 5.2).

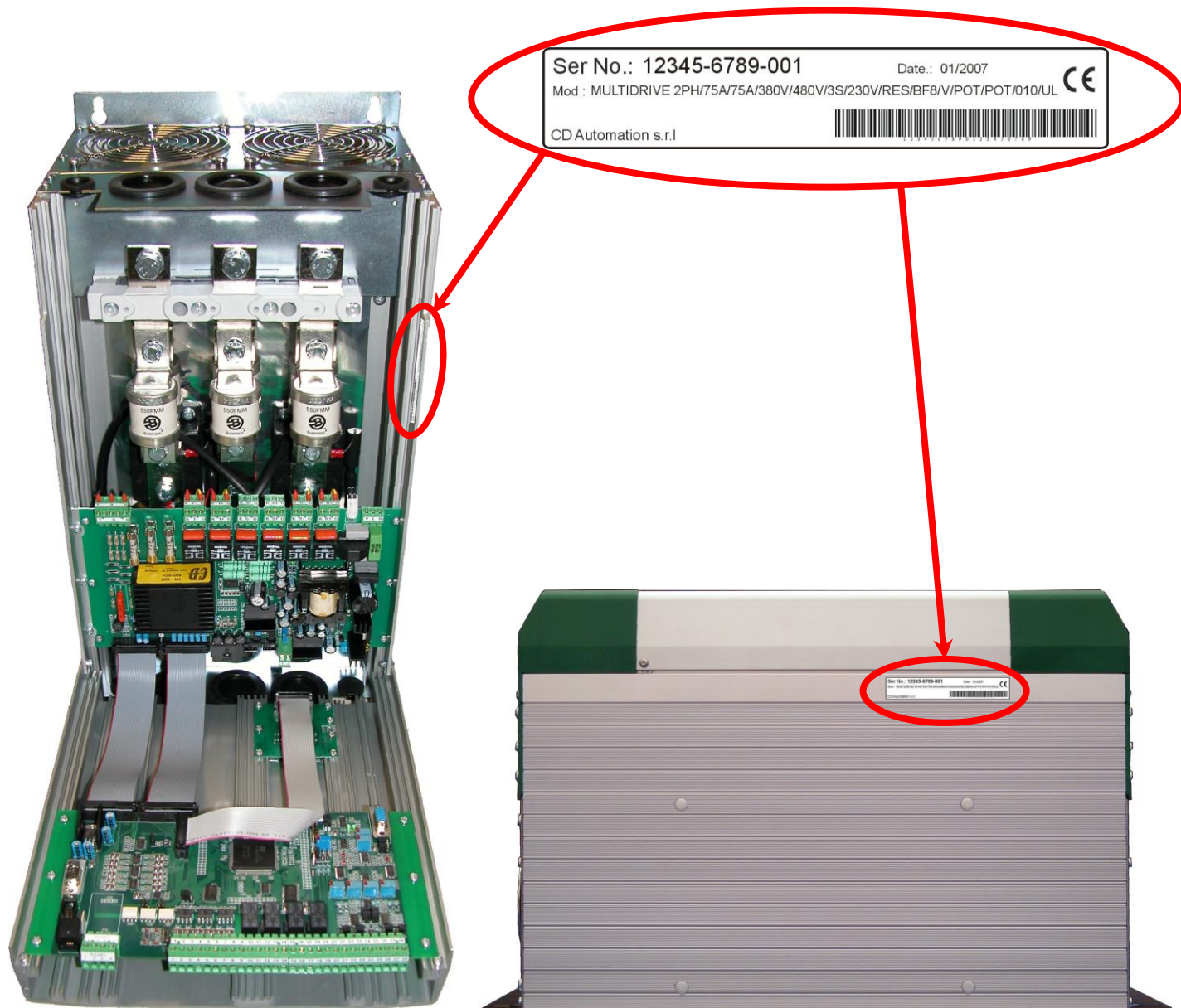

5.2 Order Code

Note 1

MULTIDRIVE 2PH		1	2	3	4	5	6	7	8	9	10	11	12	13	14	15	16
		M	2	-	-	-	-	-	-	-	-	-	-	-	-	-	-
4, 5, 6		Current		8		Aux. Voltage supply		12		Option (3)		15		Manual			
Description code	Numeric code	Description code	Numeric code	Description code	Numeric code	Description code	Numeric code	Description code	Numeric code	Description code	Numeric code	Description code	Numeric code	Description code	Numeric code	Description code	Numeric code
45A	0 0 4 5	110V	1	4:20mA Retransmission Load Current and Control Mode	A	4:20mA Retransmission Load Current and Control Mode	A	None	0	Italian Manual	1	Italian Manual	1	English Manual	2	English Manual	2
75A	0 0 7 5	230V	2	9		Input		13		Fan Voltage		16		Load type/Connection			
100A	0 1 0 0			Description code	Numeric code	Description code	Numeric code	Description code	Numeric code	Description code	Numeric code	Description code	Numeric code	Description code	Numeric code	Description code	Numeric code
125A	0 1 2 5	0:10V	V	0:10V Retransmission Load Current and Control Mode	V	0:10V Retransmission Load Current and Control Mode	V	Fan Voltage equal to Aux. Voltage	3	Star Connection	2	Star Connection	2	Transformer Load/Delta Connection	3	Transformer Load/Delta Connection	3
150A	0 1 5 0	4:20mA	A	10		Firing		14		Approvals		16		Star Connection			
225A	0 2 2 5	10KPot	K	Description code	Numeric code	Description code	Numeric code	CE EMC For European Market	0	cUL For American Market up to 700A (4)	L	Resistive Load/Delta Connection	1	Resistive Load/Delta Connection	1	Resistive Load/Delta Connection	1
275A	0 2 7 5	RS485	R														
400A	0 4 0 0			11		Control Mode											
450A	0 4 5 0			Description code	Numeric code	Description code	Numeric code										
500A	0 5 0 0			Burst Firing BF	B	Burst Firing BF	B										
600A	0 6 0 0			Delayed Triggering + Burst Firing DT+BF	D	Delayed Triggering + Burst Firing DT+BF	D										
850A	0 8 5 0																
7		Max Voltage															
Description code	Numeric code																
480V	4																
600V	6																
690V	7																

- Note (1):** After 16th digit write current and voltage of load inside brackets Ex. (190A-400V), this is to receive the Thyristor unit already tuned from CD Automation
- Note (2):** Rating not available at 690V
- Note (3):** In total are available 4 Analog output. One dedicated to control mode and the other 3 for current on phases 1-2-3
- Note (4):** cUL Approval up to 600A included

6 Installation



Caution: Don't install near the hot elements or near the units that could give electromagnetic interferences.

The MULTIDRIVE Thyristor unit must be always mounted in vertical position to improve air cooling on heat-sink. Maintain the minimum distances in vertical and in horizontal as represented. When more unit has mounted inside the cabinet maintain the air circulation like represented in figure. Sometimes is necessary installing a fan to have better air circulation.

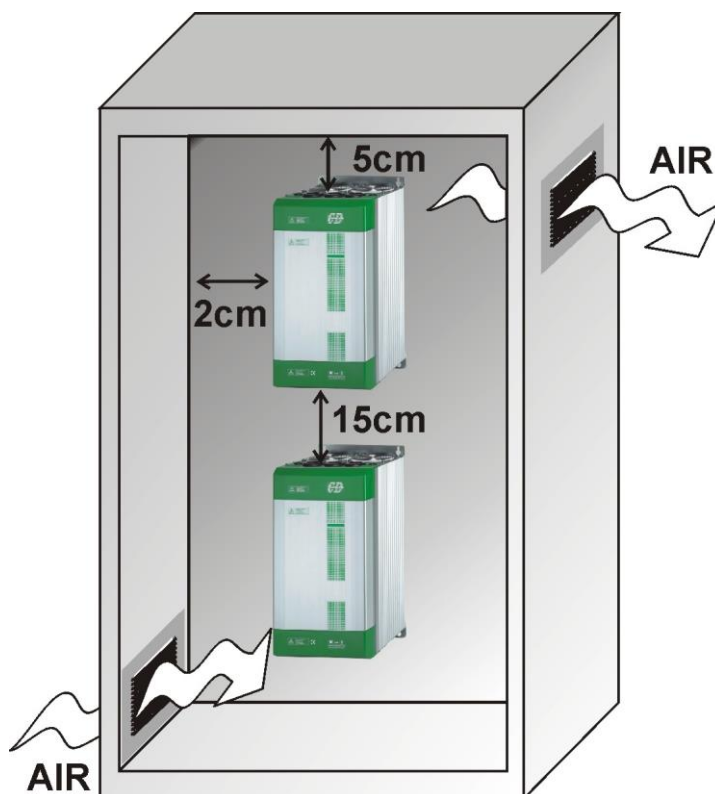

6.1 Environmental installation conditions

Ambient temperature	0-45°C at nominal current. Over 45°C use the derating curve (see par. 8.1)
Storage temperature	-25°C to 70°C
Installation place	Don't install at direct sun light, where there are conductive dust, corrosive gas, vibration or water and also in salty environmental.
Altitude	Up to 1000 meter over sea level. For higher altitude reduce the nominal current of 2% for each 100m over 1000m
Humidity	From 5 to 95% without condense and ice

6.2 Dimensions and Weight



Size	W(mm)	H(mm)	D(mm)	Weight (kg)
45A (S13)	262	440	270	18
75A (S13)	262	440	270	18
100A (S13)	262	440	270	18
125A (S13)	262	440	270	18
150A (S13)	262	440	270	18
225A (S13)	262	440	270	18
275A (S14)	262	520	270	22,5
400A (S14)	262	520	270	22,5
450A (S14)	262	520	270	22,5
500A (S14)	262	520	270	22,5
600A (S14)	262	520	270	22,5
700A (S14)	262	520	270	22,5
850A (S14)	262	520	270	22,5

6.3 Fixing holes

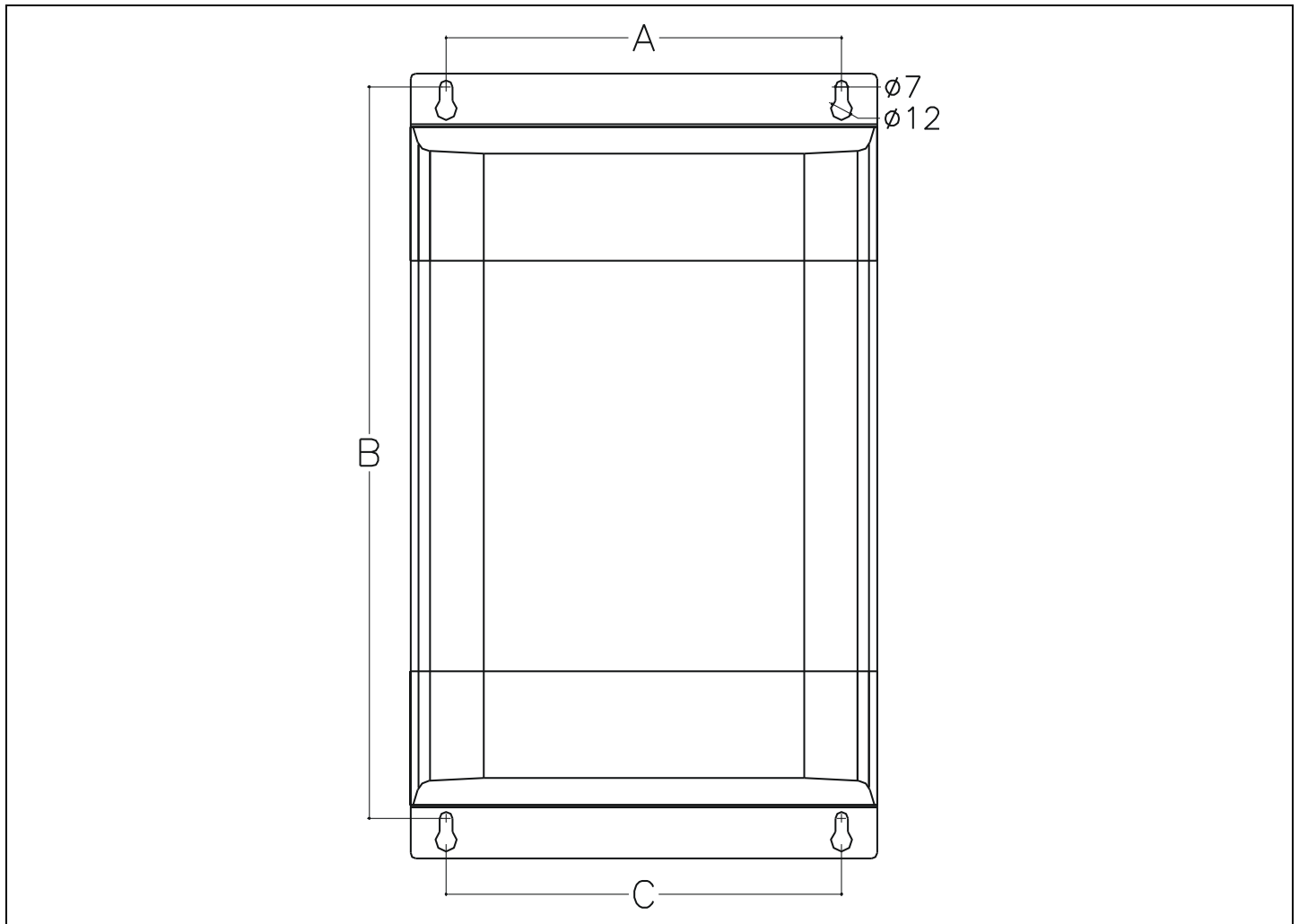

Size	A(mm)	B(mm)	C(mm)
45A (S13)	222	410	222
75A (S13)	222	410	222
100A (S13)	222	410	222
125A (S13)	222	410	222
150A (S13)	222	410	222
225A (S13)	222	410	222
275A (S14)	222	490	222
400A (S14)	222	490	222
450A (S14)	222	490	222
500A (S14)	222	490	222
600A (S14)	222	490	222
700A (S14)	222	490	222
850A (S14)	222	490	222

7 Wiring instructions



Caution: this procedure must be performed only by qualified persons.

The Thyristor unit could be susceptible to interferences lost by near equipments or by the power supply, for this reason in accord to the fundamental practices rules is opportune take some precautions:

- The electronic circuit of the Thyristor unit must be supplied from a dedicated voltage and not with inductive or capacitive loads. We recommend the use of a screened transformer.
- The coil contactor, the relays and other inductive loads must be equipped with opportune RC filter.
- Use shielded bipolar cables for all the input and output signals.
- The signal cables must not be near and parallel to the power cables.
- Local regulations regarding electrical installation should be rigidly observed.

For safety connect the heat-sink to the earth with his terminal.

7.1 Removing the cover

Instructions for open the thyristor unit size S13, S14



7.2 Wiring details

Use copper cables and wires rated for use at 75°C only.

7.2.1 Power cable torque (suggested)

Current	Connector Type	Torque Lb-in (N-m)	Wire Range AWG / kcmil	Wire Terminal
45A,75A 125A,150A, 225A	Terminal Block M8	265 (30.0)	8 4/0	Copper wire Compact (Solid) Stranded
275A	Bus Bar with M8 screw	505 (57.0)	2x1/0 300	UL Listed (ZMVV) Copper Tube Crimp. Lug
400A	Bus Bar with M10 screw	505 (57.0)	2x3/0 600	UL Listed (ZMVV) Copper Tube Crimp. Lug
450A	Bus Bar with M10 screw	505 (57.0)	Bus bar 30x6mm	
500A 600A 700A 850A	Bus Bar with M10 screw	505 (57.0)	Bus bar 60x4mm Bus bar 60x5mm Bus bar 60x6mm	

7.2.2 Power cable dimensions (suggested)

Current	Supply			Load		
	Cable		Screw M	Cable		Screw M
	mm ²	AWG		mm ²	AWG	
45A (S13)	10	8	M8	10	8	M8
75A (S13)	25	4	M8	25	4	M8
100A (S13)	35	3	M8	35	3	M8
125A (S13)	50	1	M8	50	1	M8
150A (S13)	70	1/0	M8	70	1/0	M8
225A (S13)	120	4/0	M8	120	4/0	M8
275A (S14)	2 x 70	2 x 1/0	M8	2 x 70	2 x 1/0	M8
400A (S14)	2 x 95	2 x 3/0	M10	2 x 95	2 x 3/0	M10
450A (S14)	30 x 6 mm		M10	30 x 6 mm		M10
500A (S14)	60 x 4 mm		M10	60 x 4 mm		M10
600A (S14)	60 x 5 mm		M10	60 x 5 mm		M10
700A (S14)	60 x 6 mm		M10	60 x 6 mm		M10
850A (S14)	60 x 6 mm		M10	60 x 6 mm		M10

7.2.3 Cable dimensions (suggested) of Earth and of the Command Terminals

Current	Earth			Command Terminals		
	Cable		Screw M	Cable		
	mm ²	AWG		mm ²	AWG	
45A (S13)	6	10	M8	0,50	18	
75A (S13)	10	8	M8	0,50	18	
100A (S13)	16	6	M8	0,50	18	
125A (S13)	16	6	M8	0,50	18	
150A (S13)	16	6	M8	0,50	18	
225A (S13)	25	4	M8	0,50	18	
275A (S14)	50	1	M8	0,50	18	
400A (S14)	50	1	M8	0,50	18	
450A (S14)	70	1/0	M8	0,50	18	
500A (S14)	70	1/0	M8	0,50	18	
600A (S14)	70	1/0	M8	0,50	18	
700A (S14)	70	1/0	M8	0,50	18	
850A (S14)	70	1/0	M8	0,50	18	

7.3 Power Terminals



Warning: Before connecting or disconnecting the unit check that power and control cables are isolated from voltage sources.

Terminal	Description
L1	Line Input Phase 1
L2	Line Input Phase 2
L3	Line Input Phase 3
T1	Load Output Phase 1
T2	Load Output Phase 2 - Not controlled by the thyristor
T3	Load Output Phase 3

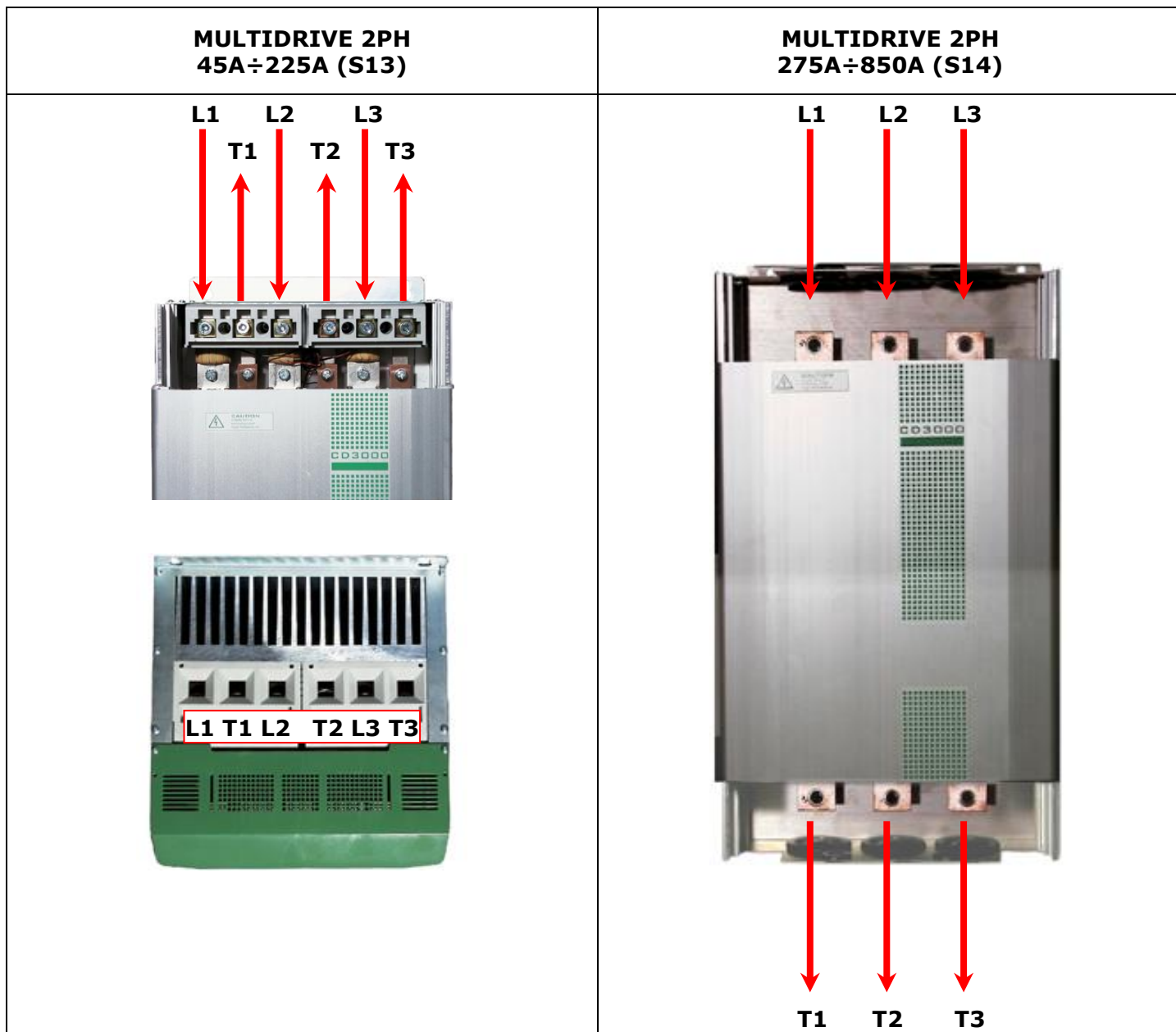

7.4 Command Terminals



Warning: Before connecting or disconnecting the unit check that power and control cables are isolated from voltage sources.

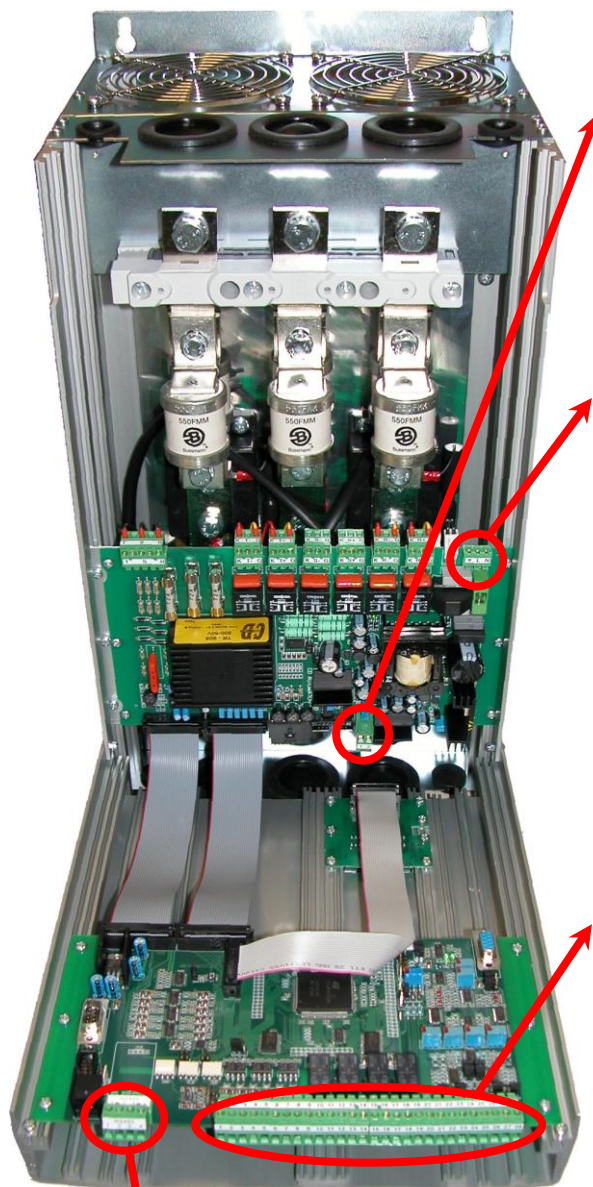

Terminal	Description
1	(+) Input External Feed-Back (0÷10Vdc)
2	(-) Input External Feed-Back (0÷10Vdc)

(see par. 12.3)

Terminal	Description
⏏	Earth
L	Voltage Supply for Electronic Boards
N	Voltage Supply for Electronic Boards

(see par. 12.2)

Terminal	Description
1	Isolated output +24Vdc MAX 20mA
2	GND for Digital Input
3	Digital Input: Reset Alarm
4	Digital Input: Start/Stop
5	Digital Input: Enable
6	Digital Input: External Alarm
7	Digital Input: Calibration
8	Digital Input: Configurable
9	Output relay: Run
10	Common of the contact relay: Run
11	Output relay 1: Critical Alarm
12	Output relay 2: Configurable
13	Output relay 3: Configurable
14	Common of the contact relay 2,3 e 4
15	Common for Analogue Output 4÷20mA
16	Common for Analogue Output 0÷10Vdc
17	(+)Analogue Input 1: Primary
18	(-)GND Analogue Input 1
19	(+)Analogue Input 2: Secondary
20	(-)GND Analogue Input 2
21	(+)Analogue Input 3: Ext. Current Profiler
22	(-)GND Analogue Input 3
23	Analogue Output 1: Power
24	Analogue Output 2: Current RMS phase L1
25	Analogue Output 3: Current RMS phase L2
26	Analogue Output 4: Current RMS phase L3
27	Output +10Vdc MAX 5mA
28	GND for Analogue Input

(see par. 12.4)

Terminal	Description
1	RS485 A
2	RS485 B
3	Internal use
4	Internal use

(see par. 12.9)

7.5 Diagram of control connection



Caution: this procedure must be performed only by qualified persons.

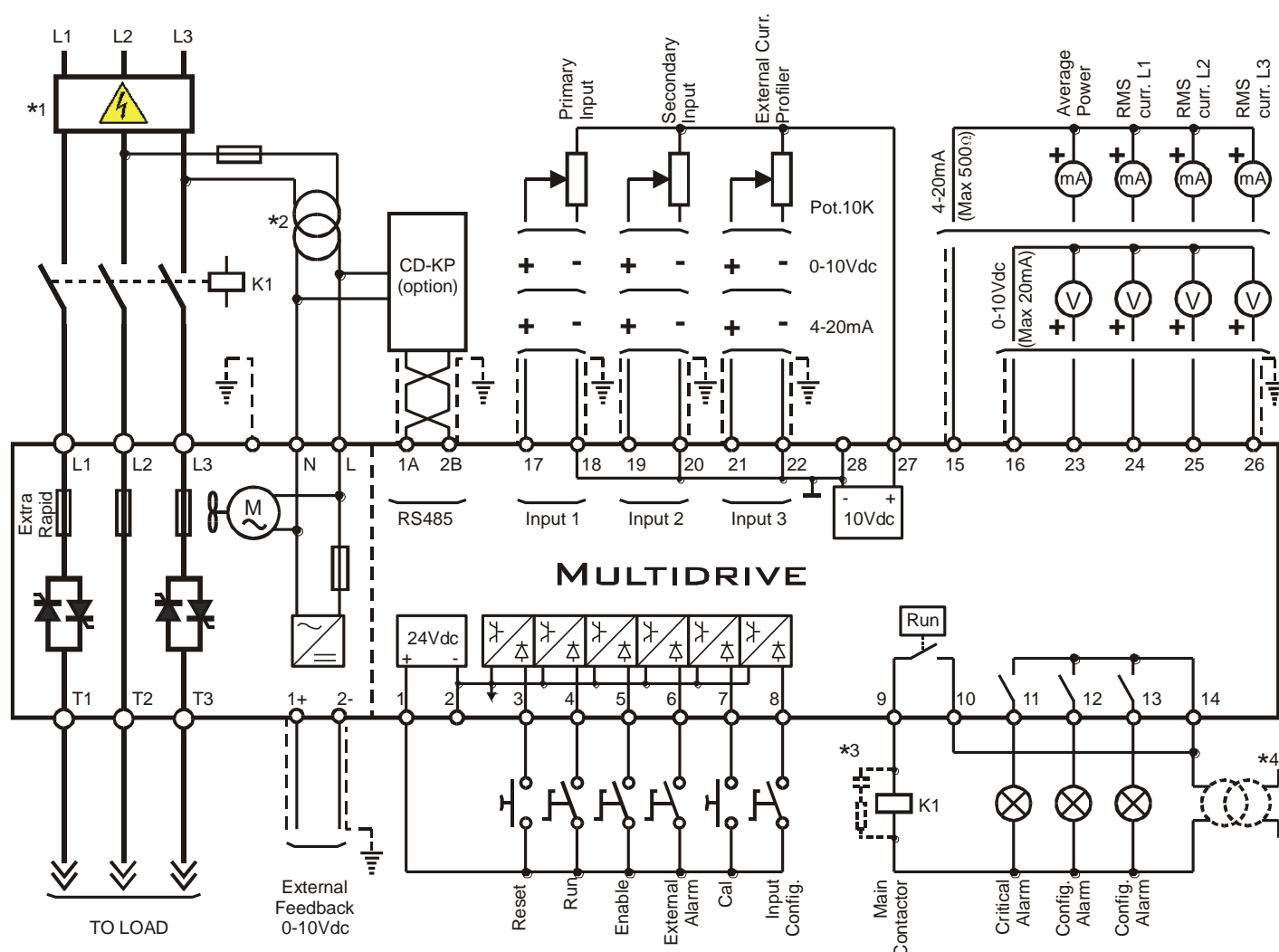

NOTE:

- *1 The user installation must be protected by electromagnetic circuit breaker or by fuse isolator.
- *2 Use an appropriate external transformer based on the voltage supply of the electronic board (see the identification label)
- *3 The coil contactor, the relays and other inductive loads must be equipped with opportune RC filter.
- *4 Before give the Start command supply the auxiliary voltage.

Load Type

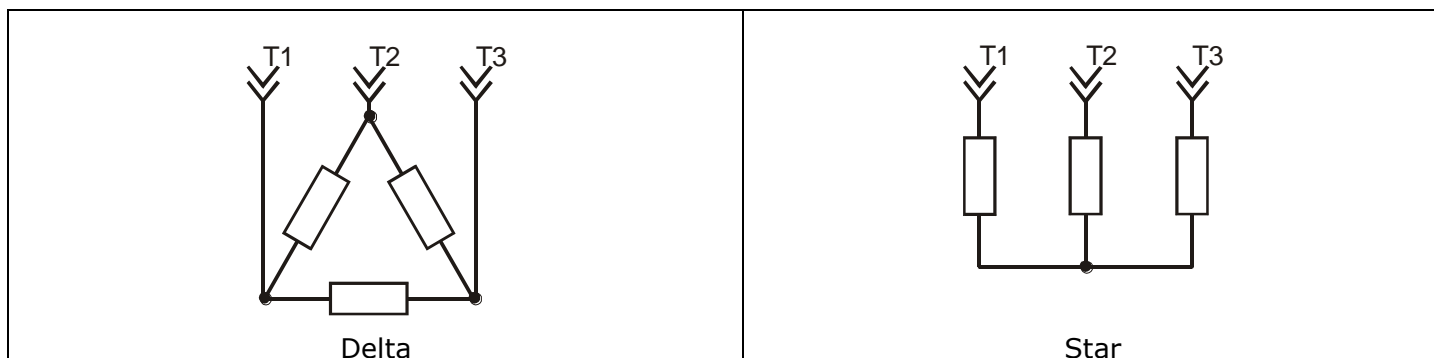

8 Power output features

Current (A)	Voltage range (V)	Repetitive peak reverse voltage		Latching current (mAeff)	Max peak one cycle (10msec.) (A)	Leakage current (mAeff)	I ² T value max tp=10msec	Frequency range (Hz)	Power loss I=Inom (W)	Isolation Voltage Vac
		(480V)	(690V)							
45A	330÷600(600V) 420÷690(690V)	1600	2200	450	1900	15	18220	47÷70	74	3000
75A	330÷600(600V) 420÷690(690V)	1600	2200	450	1900	15	18350	47÷70	136	3000
100A	330÷600(600V) 420÷690(690V)	1600	2200	450	1900	15	18900	47÷70	192	3000
125A	330÷600(600V) 420÷690(690V)	1600	2200	450	1900	15	19100	47÷70	256	3000
150A	330÷600(600V) 420÷690(690V)	1600	2200	300	4800	15	108000	47÷70	284	3000
225A	330÷600(600V) 420÷690(690V)	1600	2200	300	4800	15	109000	47÷70	478	3000
300A	330÷600(600V) 420÷690(690V)	1600	2200	300	5000	15	125000	47÷70	640	3000
350A	330÷600(600V) 420÷690(690V)	1600	2200	200	7800	15	300000	47÷70	672	3000
400A	330÷600(600V) 420÷690(690V)	1600	2200	200	7800	15	306000	47÷70	794	3000
450A	330÷600(600V) 420÷690(690V)	1600	1600	1000	8000	15	1125000	47÷70	834	2500
500A	330÷600(600V) 420÷690(690V)	1600	2200	1000	15000	15	1125000	47÷70	946	2500
600A	330÷600(600V) 420÷690(690V)	1600	2200	1000	15000	15	1125000	47÷70	1178	2500
850A	330÷600(600V) 420÷690(690V)	1600	2200	1000	15000	15	1125000	47÷70	1700	2500

8.1 Derating curve

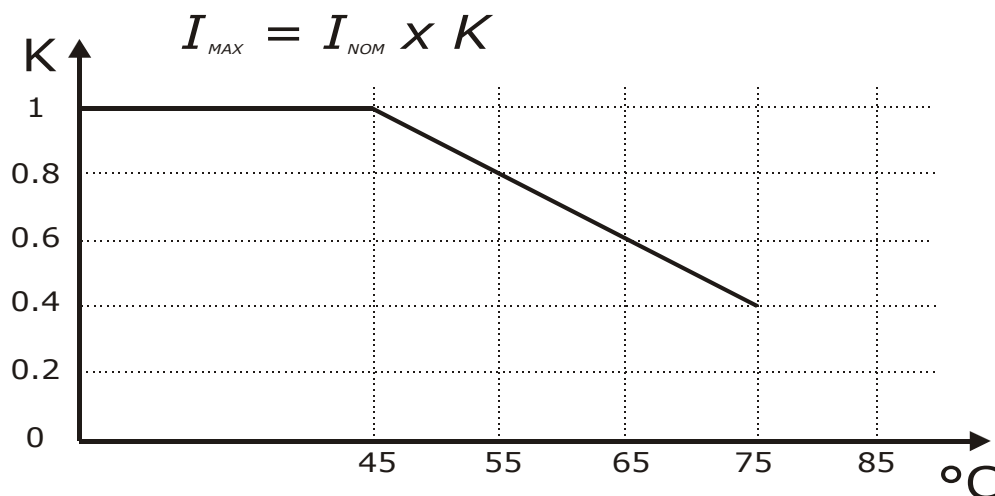

8.2 Cooling fans

The MULTIDRIVE thyristor unit is equipped with a cooling fans. The supply voltage is the same of the electronic board (see par. 12.2).

The fan's power consumption is below listed:

Size	CE Number of fans	UL US LISTED Number of fans
45A, 75A, 100A 125A, 150A, 225A	Two Fans - 30W	Two Fans - 30W
400A, 500A, 600A	Two Fans - 30W	Four Fan - 60W
275A, 450A, 700A,850A, 600A(690V)	Four Fan - 60W	Four Fan - 60W

9 Led status and Alarms

9.1 LED Status Table

On the DDC30 Electronic board there are two LED that indicates the state of the Electronic cards:

LED For All size	STATUS	DESCRIPTION
LD1	○	The power supply is not connected or fault on the electronic board
	●	Fault on the electronic board
	⦿	Electronic board is OK
LD2	○	The power supply is not connected
	●	The power supply is connected
	○	= OFF
	●	= ON
	⦿	= Flashing

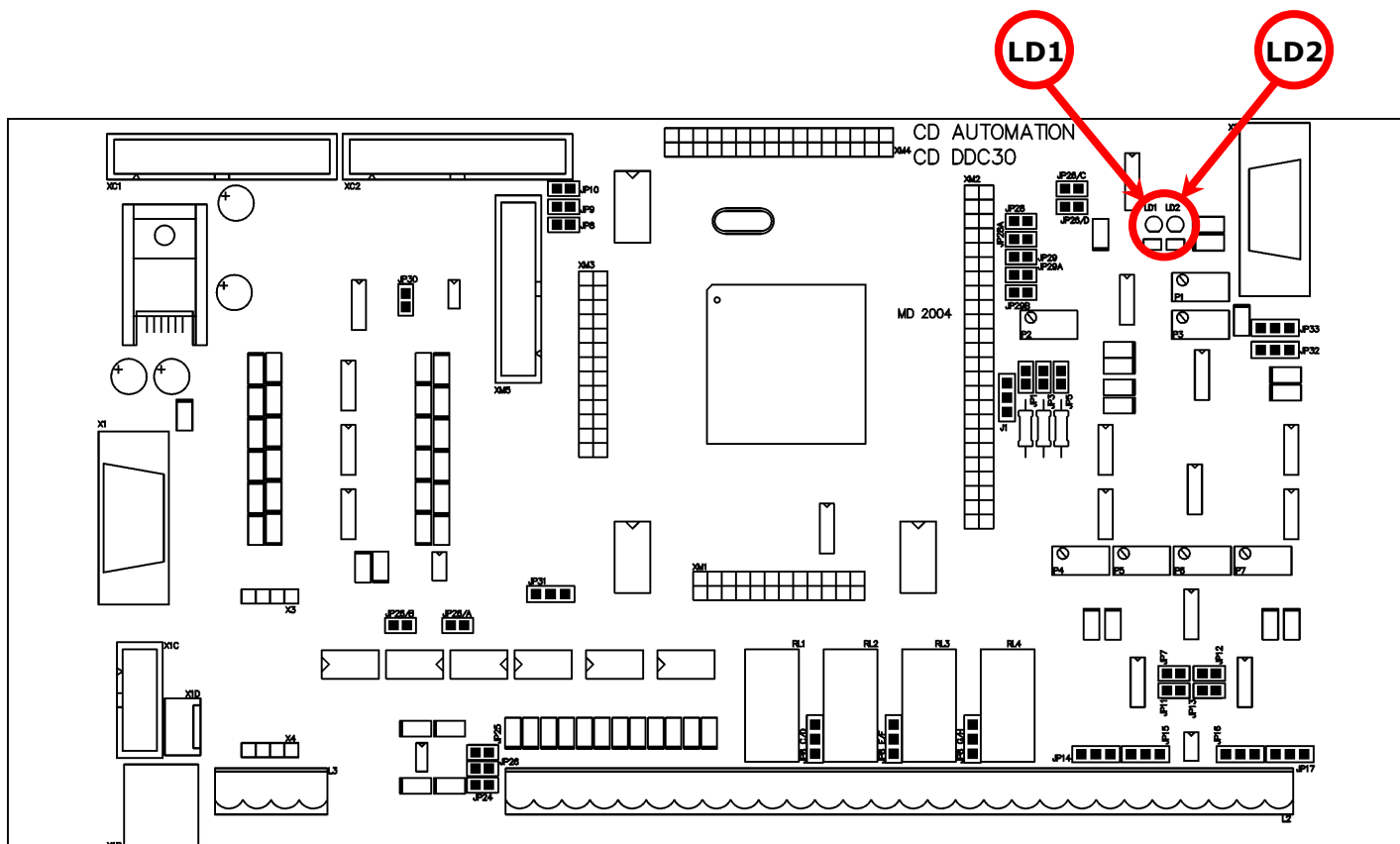

9.2 Critical Alarms

When a critical alarm is active, it stops the MULTIDRIVE thyristor unit and activates the relative digital output (terminal 11).

The parameter P001 *RL- I* allows to visualize the state of these alarms (see par. 14.1).

9.2.1 Phase loss

This critical alarm is active when one of the three phases R-S-T is loss. The phase loss could be also activated by an interrupted fuse.

For restart the thyristor unit, check the presence of the line voltage on the power terminals L1, L2, L3 and check the state of the internal fuses, When the problem is solved before to restart is necessary use the digital input: "Reset Alarm" (see par. 12.6).

9.2.2 External Alarm

This critical alarm is active when the Digital input: "External Alarm" is activated.

For restart the thyristor unit, you must disarm the external alarm. When the problem is solved before to restart is necessary use the digital input: "Reset Alarm" (see par. 12.6).

9.2.3 Heat-sink Over temperature

This critical alarm is active when the thermal switch mounted on the heat-sink is activated.

For restart the thyristor unit, you must wait that the heat-sink returns at the safety temperature.

When the problem is solved before to restart is necessary use the digital input: "Reset Alarm" (see par. 12.6).

If this alarm becomes active, check if the indications described in the "par. 6" of this manual are respected.



Caution: *this procedure must be performed only by qualified persons.*

9.3 Not Critical Alarm

The Not Critical Alarm, doesn't stop the MULTIDRIVE thyristor unit, but is possible to associate an digital output at these alarms (see par. 12.7).

The parameter P002 R_{L_2} allows to visualize the state of these alarms (see par. 14.1).

9.3.1 SCR Short Circuit

This alarm is active when MULTIDRIVE read the output current in absence of the input signal. This is possible if there are a short circuit on the thyristor or if there are a wrong wiring of the load.

When the problem is solved is necessary use the digital input: "Reset Alarm" (see par. 12.6).

9.3.2 Unbalanced Load

This alarm is active when one of the three load current (read on the terminals T1, T2, T3) differs from the others more than 30%.

The unbalanced alarm could be active also if there are a wrong wiring of the load.

When the problem is solved is necessary use the digital input: "Reset Alarm" (see par. 12.6).

9.3.3 Heater Break alarm (HB)

This alarm is active when the load current decrease under the threshold set on the parameter P066 Hb_5 (see par. 14.3).

The Heater Break alarm could be active also if there are a wrong wiring of the load.

When the problem is solved is necessary use the digital input: "Reset Alarm" (see par. 12.6).

The Heater Break alarm to work properly must have an input signal more then 25% of the nominal current value.



Caution: *In the first start, and each time that the load is replaced, it's necessary make the Calibration procedure.*

9.4 Calibration Procedure

The Calibration procedure is an automatic procedure that save in memory the three different values of load current (for each phase)

This procedure is necessary if you use the Burst Firing (BF) or if you use the Heater Break Alarm.

To make the Calibration procedure follow these steps:

- Give the power supply and start the thyristor unit (see par. 12.6).
- Activate the digital input: "Cal" (terminal 6).
- The MULTIDRIVE thyristor unit give the maximum output voltage.
- After a few seconds the values of voltage and current are stored in memory.
- The MULTIDRIVE thyristor unit returns to the initial situation.
- Stop the thyristor unit.

The Calibration procedure is done.

10 Control Panel

The Control Panel is placed on the front of the thyristor unit, on his display you can visualize the alarms, the input and output signals and all the configuration parameters (see par. 14).

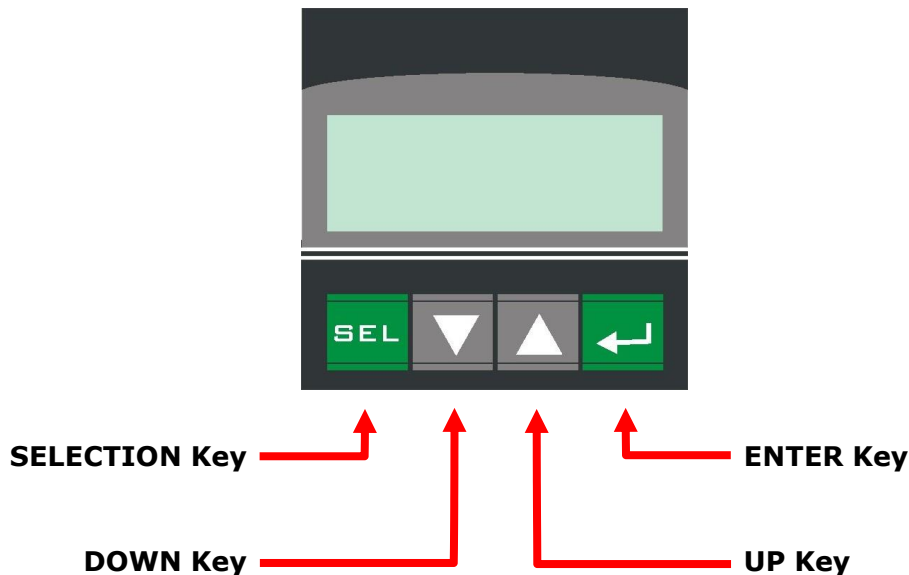

The function keys is the following:

- The SELECTION key is used for enter and exit from the menu.
- The UP key and DOWN key is used to scroll the parameters in the menu and to change data.
- The ENTER key is used to edit the parameters and to save the modified values.

The Control Panel have three menu, and to enter in one of them you must set correctly the parameter P000 *PASS* :

- Operator Menu (P000 *PASS* = 0)
This menù contains a reading parameters that give information on the state of the unit, it include also the base parameters for quick start, like the value of current and voltage load and the Set-point data.
- Hardware Menu (P000 *PASS* = 5)
This menu contains all the configuration parameters for analogic and digital I/O, and the parameters to set the serial port like the address and the baudrate.
- Setup Menu (P000 *PASS* = 10)
This menù contains all the setting parameters to configure the thyristor unit, like the firing type, the current limit, [ecc].

10.1 Scroll the parameters

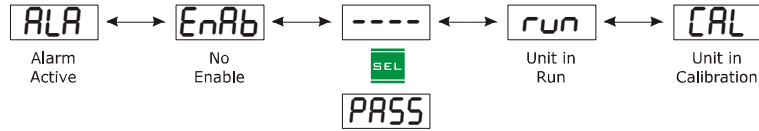

Operator Menu	Hardware Menu	Setup Menu
0000	0005	0010
PASS	PASS	PASS
Status code Alarm 1 AL_1	Save value min input 1 L.A1	Set Firing type Fir
Status code Alarm 2 AL_2	Save value max input 1 H.A1	Set HB sensitivity Hb_S
Setpoint select Analog/Digital L_r	Save value min input 2 L.A2	Set feed-back type FEEd
Set digital setpoint value L.SP	Save value max input 2 H.A2	Set Burst Firing cycles bF_n
Read analog setpoint value r.SP	Save value min input 3 L.A3	Set delay triggering dt
Read voltage power supply U.Ln	Save value max input 3 H.A3	Current limit select Analog/Digital CL_1
Set max output Outn	Set Offset Analog Output o4nA	Set Current Limit value CL
Set ramp up rP_u	Configure Digital input C_d_1	Set Load type LoAd
Set ramp down rP_d	Set Gain Analog output 1 G.A1	End
Read Average Voltage Output Uout	Set Gain Analog output 2 G.A2	
Read Average Power Output Po	Set Gain Analog output 3 G.A3	
Current rms value on Phase R A_r	Set Gain Analog output 4 G.A4	
Current rms value on Phase S A_s	Configure Digital output 2 do_2	
Current rms value on Phase T A_t	Configure Digital output 3 do_3	
Set Load Voltage U.OP	Set Baud rate Serial port bAud	
Set Load Current A.Lo	Set Address Serial port Addr	
End	End	

11 Firing type

Choose an correct firing type allows to optimize the thyristor unit for the installed load.

The firing type has already configured in line with customer requirements that are defined in the Order Code. The Order Code is written on the identification label.

However, if you wish to change the firing type you can use the software configurator or the Control Panel (see par. 10).



Caution: *this procedure must be performed only by qualified persons.*

11.1 Burst Firing (BF)

The Burst Firing is a burst of consecutive cycles, the consecutive cycles ON are selectable between 2 and 255, with input signal equal at 50%.

Burst Firing is a method zero crossing that it reduces the electromagnetic interferences because the thyristor switches at zero voltage crossing.

The example show the Burst Firing with Burst cycles: P083 $bF_{-n} = 4$

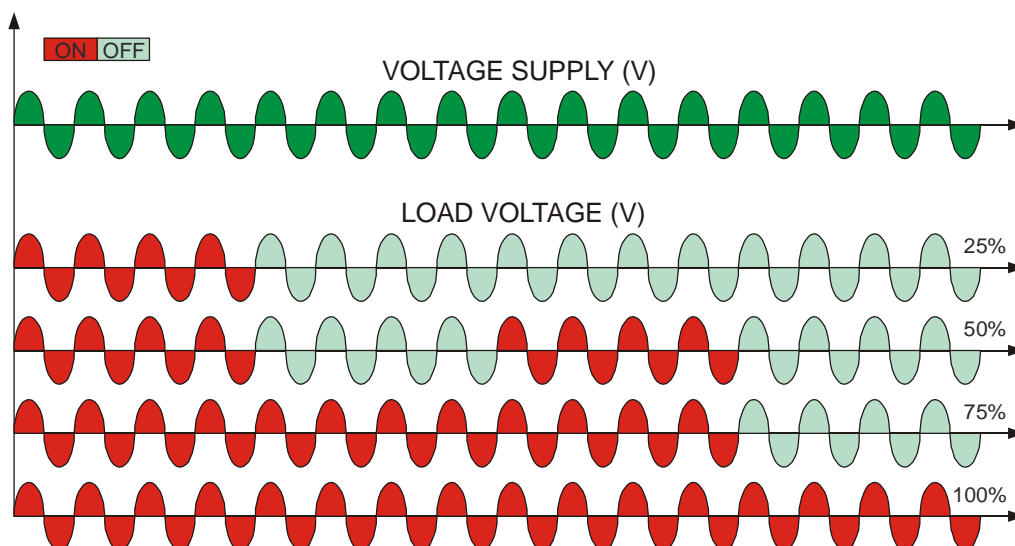

11.1.1 Suggested recipe for Burst Firing

The firing type has already configured in line with customer requirements that are defined in the Order Code. The Order Code is written on the identification label.

However, if you wish to change the firing type you can use the software configurator or the Control Panel (see par. 10).



Caution: this procedure must be performed only by qualified persons.

OPERATOR MENU					
Parameter	Name	Value	Description	UM	Mode
P003 (H03)	L--r	0	Setpoint selection Analog/Digital		R/W
P004 (H04)	L _{SP}		Digital Setpoint value	%	R/W
P019 (H13)	O _{ut}	100	Maximum Output	%	R/W
P024 (H18)	rP _u	0	Setpoint Ramp Up	Sec	R/W
P025 (H19)	rP _d	0	Setpoint Ramp Down	Sec	R/W
P116 (H74)	U _{OP}	V Load	Operative load voltage	V	R/W
P119 (H77)	A _{Lo}	I Load	Load nominal current	A	R/W

SETUP MENU					
Parameter	Name	Value	Description	UM	Mode
P023 (H17)	F _{ir}	0	Firing Type		R/W
P066 (H42)	Hb _S	20	HB sensitivity	%	R/W
P070 (H46)	FEEd	1	Feed back selection		R/W
P083 (H53)	bF _n	8	Burst Firing Cycles	Cycles	R/W
P085 (H55)	dt	0	Delay triggering	°	R/W
P090 (H5A)	IL _i	1	Limit current Analog/Digital		R/W
P091 (H5B)	IL	0÷100,0□	Digital Limit current value	%	R/W
P098 (H62)	LoAd	0÷2	Define the load type connection: 0=star 2=delta		R/W

= modification is not necessary
 = modification is necessary

□ If the current limit is not used set this value to 100,0%.

11.2 Delay Triggering (DT)

The Delay Triggering firing is used to control a primary of transformer coupled with the normal resistances on the secondary (N.B. don't connect cold resistances on the secondary like: Superkanthal, Molybdenum, Platinum, Tungsten, Quartz Lamp).

For an inductive load (ex transformer), switching the thyristors at zero crossing can generate transient over currents that can blow the fuses, to avoid this problem you must use the Delay Triggering. This firing delay the first half cycle of Burst for an angle from 0 to 100° relative to the zero, besides all the first burst start with soft start ramp to reduce the inrush current during the cycle of magnetization.

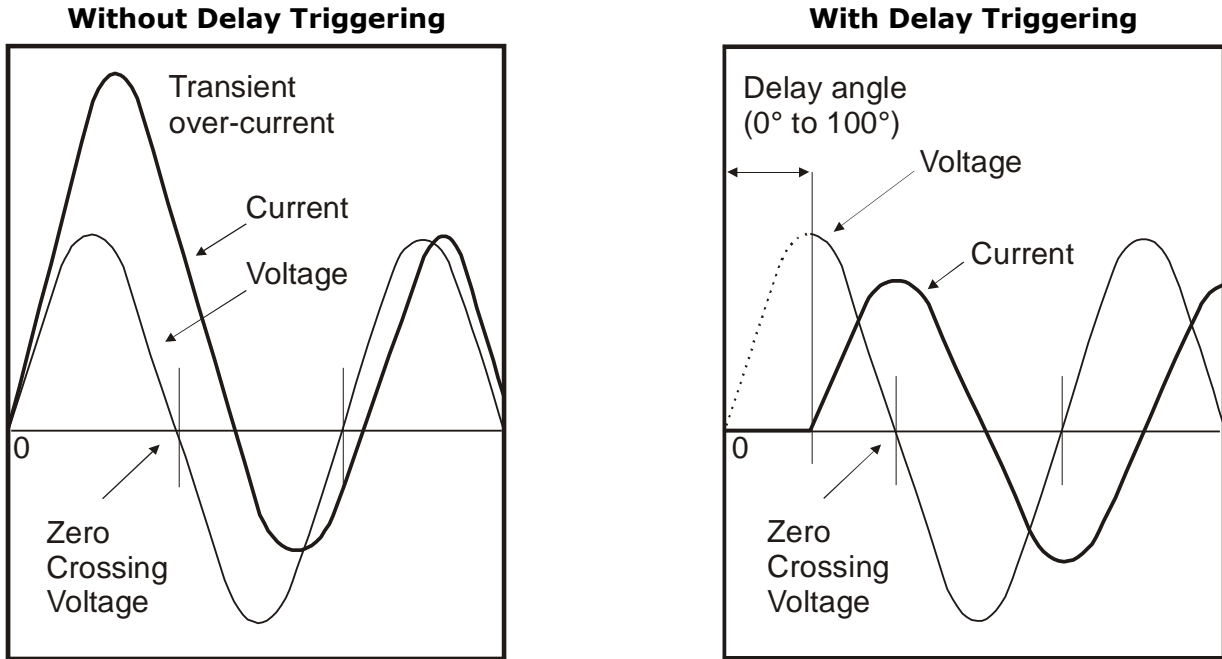

For understand the Delay Triggering firing, we have represented the waves generate by vectors that rotates in counterclockwise:

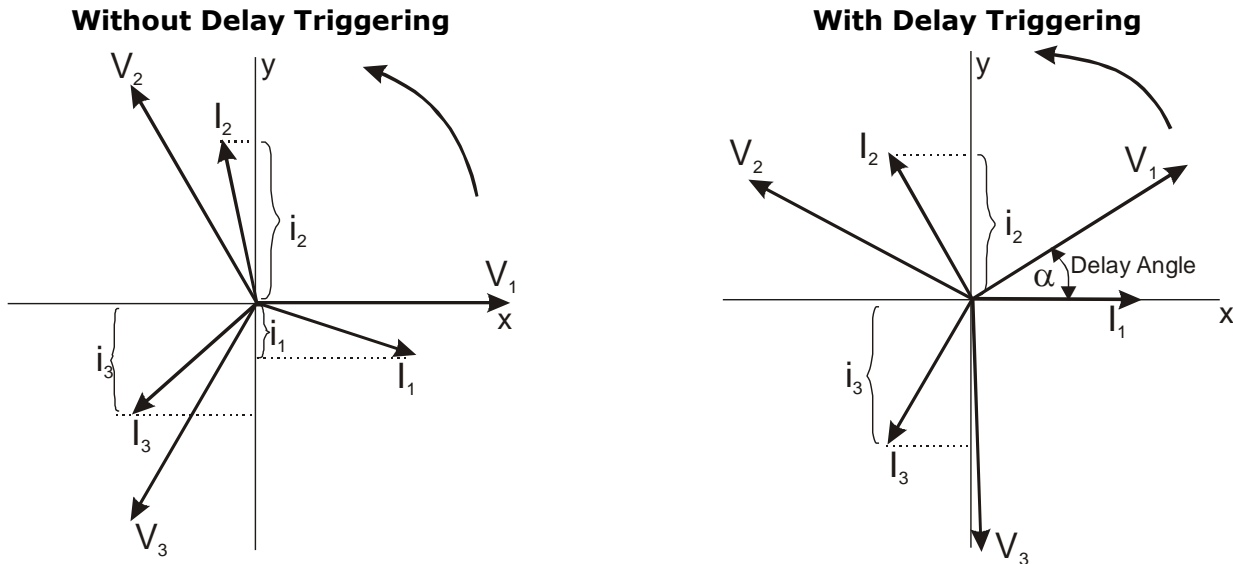

Without delay at zero crossing when V_1 is to zero (projected on the X axis) the unit switch On. In this case the instantaneous value of the currents are i_1 , i_2 and i_3 and this condition, for the curve of magnetization, could generate transient over currents that can blow the fuses.

With Delay Triggering the firing of the thyristor are triggered with a delay until the instantaneous value of the current $i_1=0$, i_2 positive and i_3 negative like represented.

In this case the risk of transient over currents is reduced and the fuses don't blow.

The angle alpha is the delay to have $i_1=0$ and this angle depends on the power factor.

The delay angle suggest for most applications is 80°

11.2.1 Suggested recipe for Delay Triggering

The firing type has already configured in line with customer requirements that are defined in the Order Code. The Order Code is written on the identification label.

However, if you wish to change the firing type you can use the software configurator or the Control Panel (see par. 10).



Caution: this procedure must be performed only by qualified persons.

OPERATOR MENU					
Parameter	Name	Value	Description	UM	Mode
P003 (H03)	L _{rr}	0	Setpoint selection Analog/Digital		R/W
P004 (H04)	L _{SP}		Digital Setpoint value	%	R/W
P019 (H13)	O _{ut}	100	Maximum Output	%	R/W
P024 (H18)	r _{P_u}	0÷1000 ²	Setpoint Ramp Up	Sec	R/W
P025 (H19)	r _{P_d}	0÷1000 ²	Setpoint Ramp Down	Sec	R/W
P116 (H74)	U _{OP}	V Load	Operative load voltage	V	R/W
P119 (H77)	A _{Lo}	I Load	Load nominal current	A	R/W

SETUP MENU					
Parameter	Name	Value	Description	UM	Mode
P023 (H17)	F _{ir}	2	Firing Type		R/W
P066 (H42)	H _{b_S}	20	HB sensitivity	%	R/W
P070 (H46)	F _{EE} d	1	Feed back selection		R/W
P083 (H53)	b _{F_n}	8	Burst Firing Cycles	Cycles	R/W
P085 (H55)	d _t	0÷100 ³	Delay triggering	°	R/W
P090 (H5A)	C _{L_1}	1	Limit current Analog/Digital		R/W
P091 (H5B)	C _L	100,0□	Digital Limit current value	%	R/W
P098 (H62)	Lo _{Ad}	0÷2	Define the load type connection: 0=star 2=delta		R/W

= modification is not necessary
 = modification is necessary

□ With 2PH version and Delay triggering, the current limit is not used.

² If don't use the setpoint ramp set this value to 0.

³ The delay angle suggest for most applications is 80°

11.3 Action of the Limit Current

The Current Limit for 2PH version is available only with burst firing type.

It control the output action to maintain the three average currents under the set value.

When the average currents exceeds this value, the output action is decreased up to reach the current limit set.

I Load \leq I Limit Set

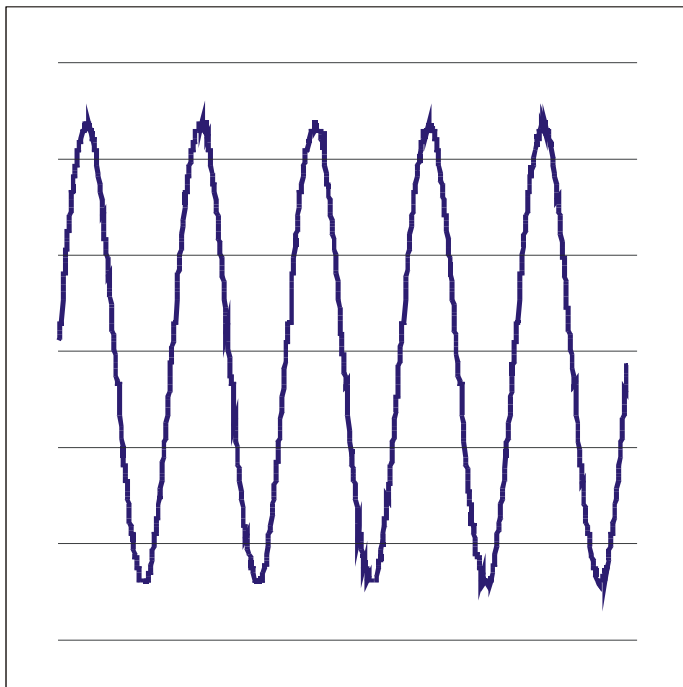

I Load $>$ I Limit Set

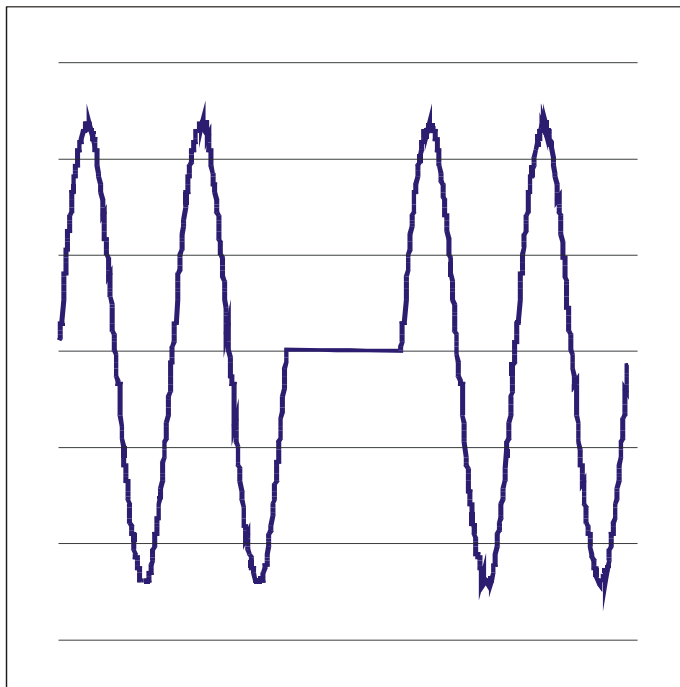

11.3.1 Current Limit Procedure

The current limit could be set through the analogic input 3: External Current Profiler, or in digital mode through the parameter P091 $\llcorner L$.

To select Analog/Digital mode use the parameter P090 $\llcorner L_1$ (see par. 14.3).

To make Current Limit Procedure follow these steps:



Caution: this procedure must be performed only by qualified persons.

- Give the power supply and set the current limit to zero:
 - In analog mode, set the analog input 3 at the min value (ex. 0V for 0÷10Vdc or 4 for 4÷20mA)
 - In digital mode, set the parameter P091 $\llcorner L = 0$
- Start the MULTIDRIVE thyristor unit (see par. 12.6).
- Set the primary input or the setpoint value at 100% (see par. 12.4).
- Increase the current limit until to reach the desired value.
- Stop the thyristor unit.

The Current Limit Procedure is done.

11.4 Feed-back type

The Feed-back type has already configured in line with customer requirements that are defined in the Order Code. The Order Code is written on the identification label.

However, if you wish to change the Feed-back type you can use the software configurator or the Control Panel (see par. 10).



Caution: *this procedure must be performed only by qualified persons.*

The Feed-back type is defined by the parameter P070 *FEEd* (see par. 14.3).

If the configurable digital input has set like Feed-Back Selection (see par. 12.6), it's possible to change the select Feed-Back with the Voltage Feed-Back (V) simply activating the input.

The feed-back defines the Control Mode. It's possible to have:

- V=Voltage feed-back.
The input signal is proportional to the output voltage. This means that input signal becomes a voltage demand. This control mode compensates the voltage fluctuation of the incoming line supply.
- I=Current feed-back.
The input signal is proportional to the current output. This means that input signal becomes a current demand. This control mode maintain the current also if the load impedance changes.
- W=Power feed-back.
The input signal is proportional to the power output. This means that input signal becomes a power demand. The power remains constant also if voltage and load impedance change. This control mode is used with silicon carbide elements that change its resistive value with temperature and with age. In addition it compensates the voltage fluctuation of the incoming line supply.
- EX=External feed-back (0÷10Vdc).
The input signal is proportional to an external signal. This means that input signal becomes a demand to maintain this signal always constant. This control mode is used for example with galvanic systems, where it's necessary to control the current value through the electrodes.

12 Connection description

12.1 Access to the Electronic boards

To have access to the electronic boards the user must removing the unit's cover (see par.7.1)



Warning: Before operate, be sure that power and control cables are isolated from voltage sources

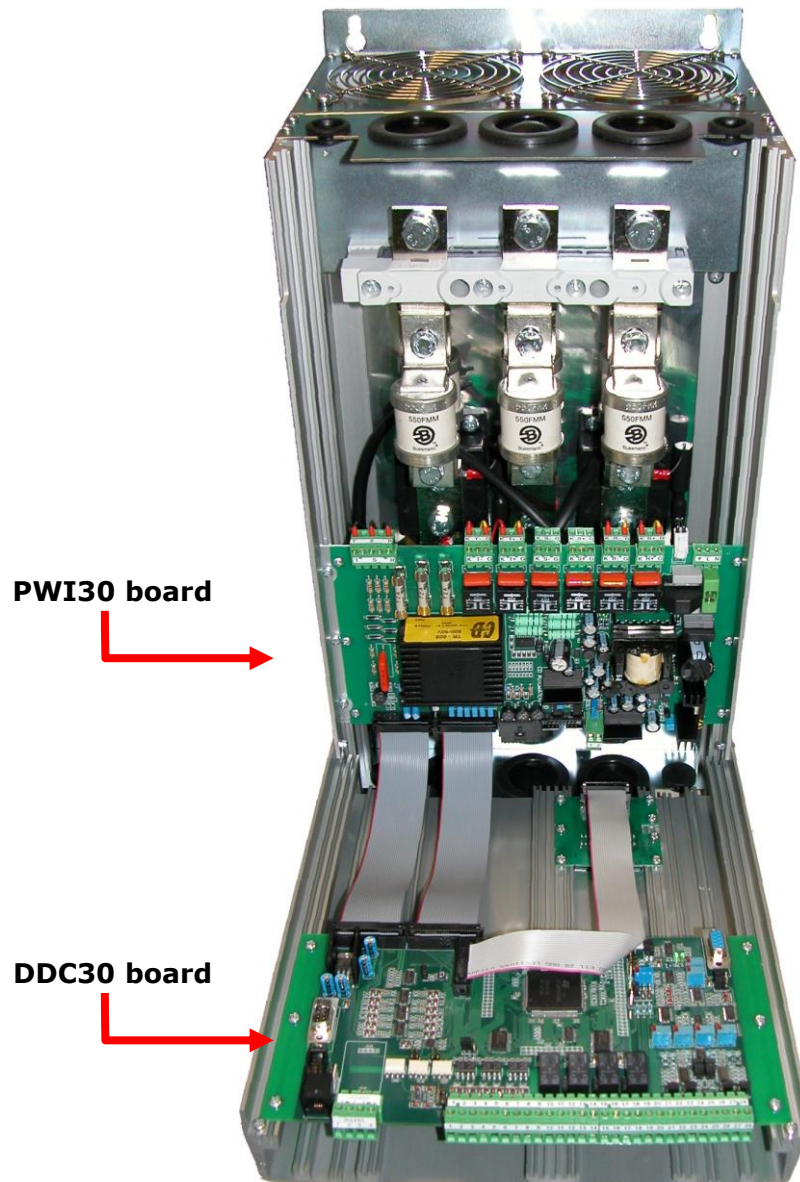

12.2 Supply the Electronic Board PWI30

The MULTIDRIVE thyristor unit, to work, requires a voltage supply for the electronic boards. This voltage is used also to supply the internal fans.
 The consumption is 20VA max, at this you must add the consumption of the internal fans (see par. 8.2).

The voltage supply for the electronic boards is configured in line with customer requirements that are defined in the Order Code. The Order Code is written on the identification label



Warning: Before connecting or disconnecting the unit check that power and control cables are isolated from voltage sources.

Terminal	Description
⏚	Earth
L	Voltage Supply for Electronic Boards
N	Voltage Supply for Electronic Boards

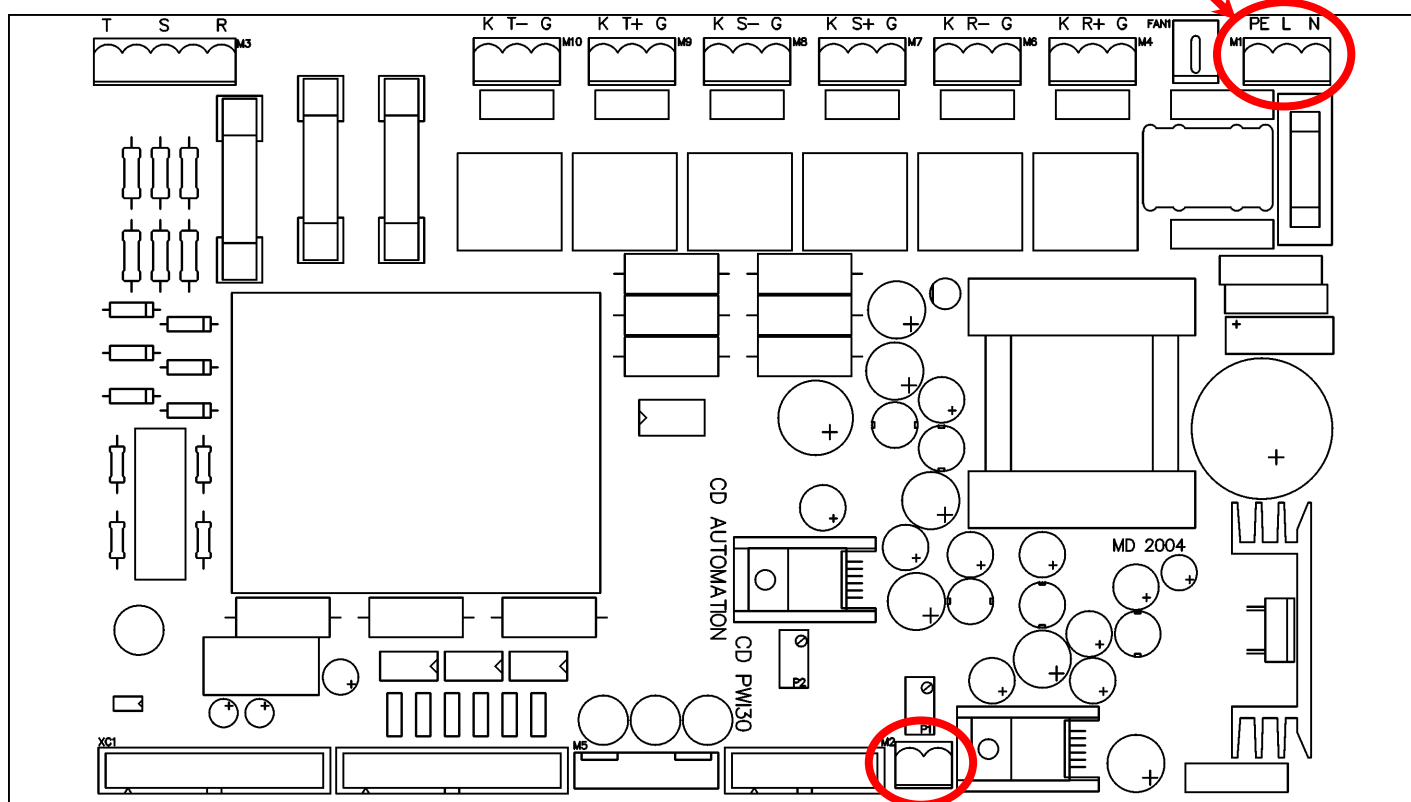

12.3 External Feed-Back

Terminal	Description
1	(+)Input External Feed-Back (0÷10Vdc)
2	(-)Input External Feed-Back (0÷10Vdc)

The MULTIDRIVE thyristor unit has an input for external Feed-Back. It can be activated by the Feed-Back select (see par. 11.4)

12.4 Analog Inputs

The MULTIDRIVE thyristor unit has 3 configurable analog inputs (0÷10V, 4÷20mA, ecc):
The primary input for the analog setpoint, the secondary input for the setpoint correction and the External Current Profiler for the current limit.

12.4.1 Primary Input (Terminals 17 and 18 - see par. 7.4)

The primary input is already configured in line with customer requirements that are defined in the Order Code. The Order Code is written on the identification label.
However, if you wish to change the primary input (ex. from 0÷10V to 4÷20mA) proceed as follows:



Caution: this procedure must be performed only by qualified persons

Type	Input features		JP1
0÷10V	Impedance	47KΩ	Open
POT	Impedance	10KΩ min	Open
4÷20mA	Impedance	470Ω	Close

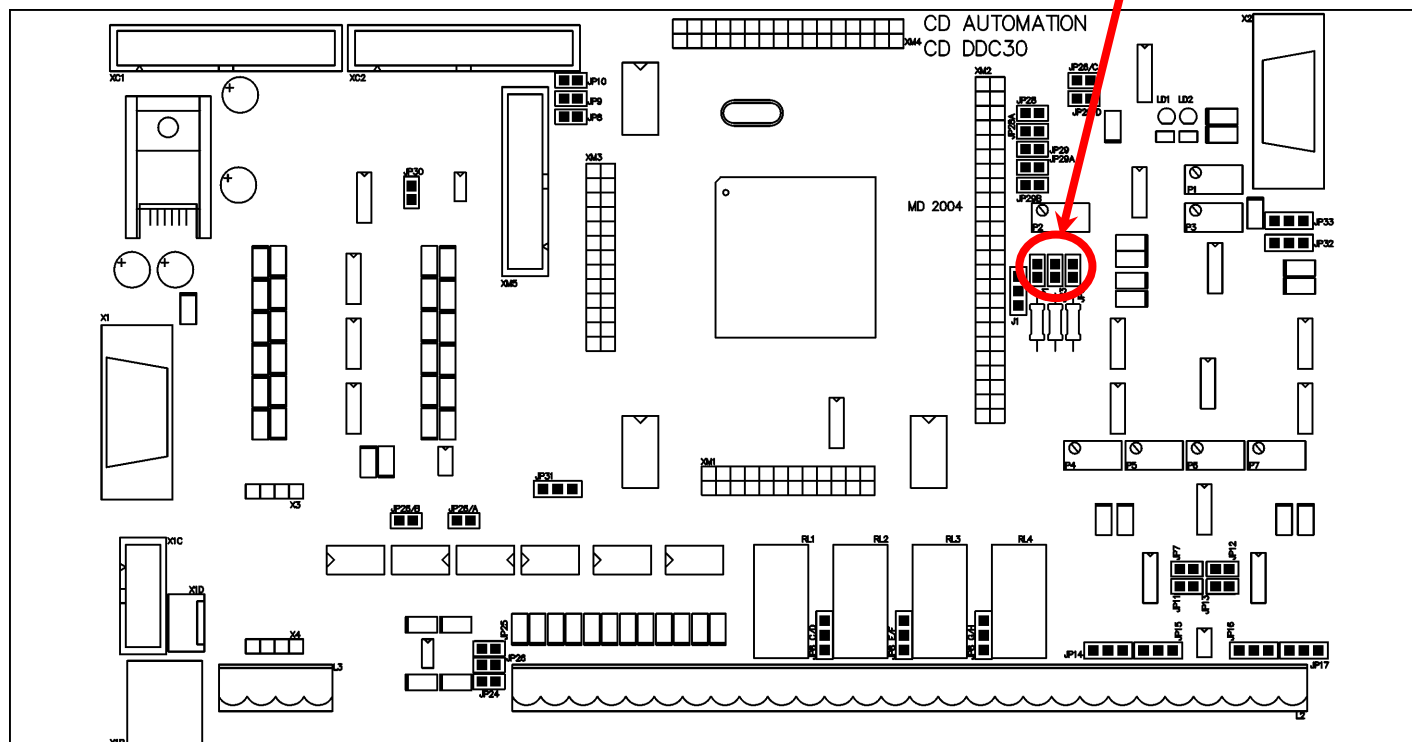
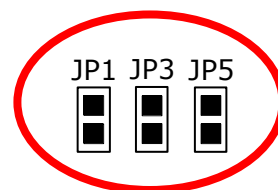

Primary Input calibration procedure

When you change the hardware setting is necessary make the Input calibration procedure.
To make the Input calibration procedure follow these steps:

- Give the power supply.
- With Control Panel go in the Hardware menu (P000 *PR55* = 5)
- Set the input signal to the min value (ex. 0V for 0÷10V or 4mA for 4÷20mA)
- Set the parameter P057 *L i A* = 1
- Press ENTER key
- Set the input signal to the max value (ex.10V for 0÷10V or 20mA for 4÷20mA)
- Set the parameter P058 *H i A* = 1
- Press ENTER key

The Input calibration procedure is done.

12.4.2 Secondary Input (Terminals 19 and 20 - see par. 7.4)

The secondary input for the setpoint correction is already configured in line with customer requirements that are defined in the Order Code. The Order Code is written on the identification label. However, if you wish to change the secondary input (ex. from 0÷10V to 4÷20mA) proceed as follows:



Caution: this procedure must be performed only by qualified persons

Type	Input features		JP3
0÷10V	Impedance	47KΩ	Open
POT	Impedance	10KΩ min	Open
4÷20mA	Impedance	470Ω	Close

Secondary Input calibration procedure

When you change the hardware setting is necessary make the Input calibration procedure. To make the Input calibration procedure follow these steps:

- Give the power supply.
- With Control Panel go in the Hardware menu (P000 *PASS* = 5)
- Set the input signal to the min value (ex. 0V for 0÷10V or 4mA for 4÷20mA)
- Set the parameter P059 *L AR* = 1
- Press ENTER key
- Set the input signal to the max value (ex.10V for 0÷10V or 20mA for 4÷20mA)
- Set the parameter P060 *H AR* = 1
- Press ENTER key

The Input calibration procedure is done.

12.4.3 External Current Profiler (Terminals 21 and 22 - see par. 7.4)

The External Current Profiler input is already configured in line with customer requirements that are defined in the Order Code. The Order Code is written on the identification label.

However, if you wish to change the External Current Profiler input (ex. from 0÷10V to 4÷20mA) proceed as follows:



Caution: this procedure must be performed only by qualified persons

Type	Input features		JP5
0÷10V	Impedance	47KΩ	Open
POT	Impedance	10KΩ min	Open
4÷20mA	Impedance	470Ω	Close

External Current Profiler Input calibration procedure

When you change the hardware setting is necessary make the Input calibration procedure. To make the Input calibration procedure follow these steps:

- Give the power supply.
- With Control Panel go in the Hardware menu (P000 *PASS* = 5)
- Set the input signal to the min value (ex. 0V for 0÷10V or 4mA for 4÷20mA)
- Set the parameter P061 *L AR* = 1
- Press ENTER key
- Set the input signal to the max value (ex.10V for 0÷10V or 20mA for 4÷20mA)
- Set the parameter P062 *H AR* = 1
- Press ENTER key

The Input calibration procedure is done.

12.5 Analog Outputs

The MULTIDRIVE thyristor unit has 4 configurable analog outputs (0÷10V, 4÷20mA, ecc). The output 1 is for retransmitting the average power on the three phases, and the others 3 is for the retransmitting the RMS current on the phases L1, L2 and L3

12.5.1 Output 1: Average Power (Terminals 15 and 23 or 16 and 23 - see par. 7.4)

The average power output is already configured in line with customer requirements that are defined in the Order Code. The Order Code is written on the identification label.

However, if you wish to change the average power output (ex. from 0÷10V to 4÷20mA) proceed as follows:



Caution: this procedure must be performed only by qualified persons

Type	Output features	P097 047A	JP14
0÷10V	20mA Max	0	A-B
0÷20mA	500Ω Max	0	B-C
4÷20mA	500Ω Max	1	B-C

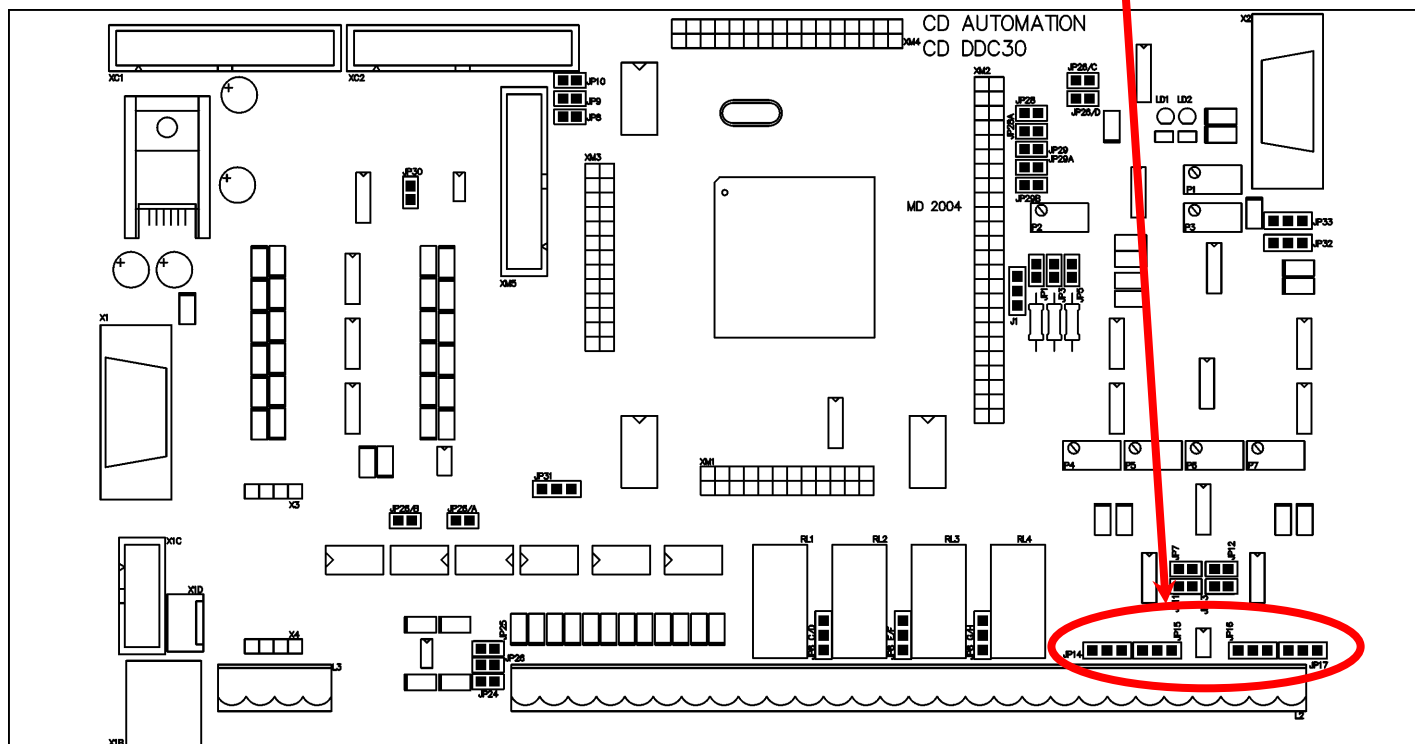
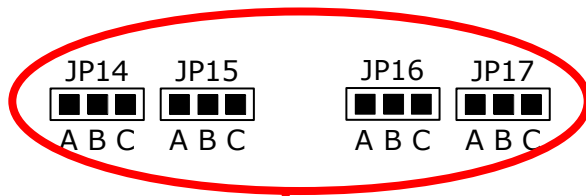

Setting the Output 1 Value

The parameter P104 G_{RI} allows to set the full scale value to have the maximum output, for example if you use an indicator with full scale 50Kw set the parameter P104 $G_{RI} = 50$.

12.5.2 Output 2: L1 RMS current (Terminals 15 and 24 or 16 and 24 - see par. 7.4)

The RMS current output is already configured in line with customer requirements that are defined in the Order Code. The Order Code is written on the identification label.

However, if you wish to change the RMS current output (ex. from 0÷10V to 4÷20mA) proceed as follows:



Caution: this procedure must be performed only by qualified persons

Type	Output features	P097 047A	JP15
0÷10V	20mA Max	0	A-B
0÷20mA	500Ω Max	0	B-C
4÷20mA	500Ω Max	1	B-C

Setting the Output 2 Value:

The parameter P106 \bar{C}_{R2} allows to set the full scale value to have the maximum output, for example if you use an indicator with full scale 50A set the parameter P106 $\bar{C}_{R2} = 50$.

12.5.3 Output 3: L2 RMS current (Terminals 15 and 25 or 16 and 25 - see par. 7.4)

The RMS current output is already configured in line with customer requirements that are defined in the Order Code. The Order Code is written on the identification label.

However, if you wish to change the RMS current output (ex. from 0÷10V to 4÷20mA) proceed as follows:



Caution: this procedure must be performed only by qualified persons

Type	Output features	P097 047A	JP16
0÷10V	20mA Max	0	A-B
0÷20mA	500Ω Max	0	B-C
4÷20mA	500Ω Max	1	B-C

Setting the Output 3 Value:

The parameter P108 \bar{C}_{R3} allows to set the full scale value to have the maximum output, for example if you use an indicator with full scale 50A set the parameter P108 $\bar{C}_{R3} = 50$.

12.5.4 Output 4: L3 RMS current (Terminals 15 and 26 or 16 and 26 - see par. 7.4)

The RMS current output is already configured in line with customer requirements that are defined in the Order Code. The Order Code is written on the identification label.

However, if you wish to change the RMS current output (ex. from 0÷10V to 4÷20mA) proceed as follows:



Caution: this procedure must be performed only by qualified persons

Type	Output features	P097 047A	JP17
0÷10V	20mA Max	0	A-B
0÷20mA	500Ω Max	0	B-C
4÷20mA	500Ω Max	1	B-C

Setting the Output 4 Value:

The parameter P110 \bar{C}_{R4} allows to set the full scale value to have the maximum output, for example if you use an indicator with full scale 50A set the parameter P110 $\bar{C}_{R4} = 50$.

12.6 Digital Input

The MULTIDRIVE thyristor unit has 6 digital inputs opto-isolated to 24Vdc.

You can activate the inputs with the internal supply (see par. 7.5) or with an external source for example the PLC.

12.6.1 Reset alarm (Terminal 3 see par. 7.4)

The Reset Alarm is used for restore the unit after an alarm occurs.

Before using this input you must resolve the fault or the alarm status come back.

12.6.2 Start/Stop (Terminal 4 see par. 7.4)

This is the start command of the MULTIDRIVE thyristor unit and active the relative digital output (terminal 9 and 10) connected to the main contactor, if no alarm occurs, the MULTIDRIVE thyristor unit give an output proportional at the input signal.

If you Remove the Start command the MULTIDRIVE thyristor unit will be stopped and the output will return at zero following the ramp. When the ramp is over the contact at the terminals 9 and 10 will be reopened and the main contactor goes down.

If the Enable input is not active, the Start/Stop command have not effect

12.6.3 Enable (Terminale 5 see par. 7.4)

The MULTIDRIVE thyristor unit, to work, must have this digital input active.

When the unit is in Run and you remove the Enable command the unit will be stopped and the output goes at zero without follow the ramp. The contact at the terminals 9 and 10 will be immediately reopened and the main contactor goes down.

12.6.4 External Alarm (Terminal 6 see par. 7.4)

The MULTIDRIVE thyristor unit, to work, must not have this digital input active.

When the unit is in Run and you active the External Alarm, the unit will be stopped and the output goes at zero without follow the ramp. The contact at the terminals 9 and 10 will be immediately reopened and the main contactor goes down. The External Alarm activates also the Critical Alarm

12.6.5 Calibration (Terminal 7 see par. 7.4)

The Calibration input activates the Calibration procedure that is necessary if you use the Burst Firing (BF) or the Heater break alarm (see par. 9.4).

12.6.6 Configurable Input (Terminal 8 see par. 7.4)

This digital input is configured by the parameter P103 \lceil_{-d} and could perform different functions:

- Additional Reset Alarm:
This function is the same of the Reset Alarm command.
- Setpoint zero:
This function forces the output at zero maintaining the Run contact closed.
- Feed-Back Selection:
With this function, when you active the input, the feed-back setted in the parameter P070 $FEEd$ change in Voltage Feed-Back (V).
- Analog/Digital Setpoint:
With this function, when you active the input, the setpoint reference change from Analog input to Digital value, setted in the parameter P004 L_{-SP} (see par. 14.1).
- External Alarm:
With this function the thyristor unit, to work, must not have this digital input active.
When the unit is in Run and you active the External Alarm, the unit will be stopped and the output goes at zero without follow the ramp. The Run contact at the terminals 13 and 14 will be immediately reopened and the main contactor goes down. The External Alarm activates also the Critical Alarm digital output.

12.7 Digital Output

The MULTIDRIVE thyristor unit has 4 digital output with relay contact (Max 500mA, 125Vac), an output control the main contactor and is a normally open (NO) fixed contact, and the others output gives indications of the alarms state, the contacts can be (NO or NC).

12.7.1 Run Relay (Terminals 9 and 10 see par. 7.4)

This digital output is used to control the main contactor, when the thyristor unit is in run the output is active and the contact is closed.

12.7.2 Critical Alarm (Terminals 11 and 14 see par. 7.4)

This digital output is active when a critical alarm occurs (see par. 9.2). The standard contact used for this output is normally open (NO), but is possible change the contact type:



Caution: this procedure must be performed only by qualified persons

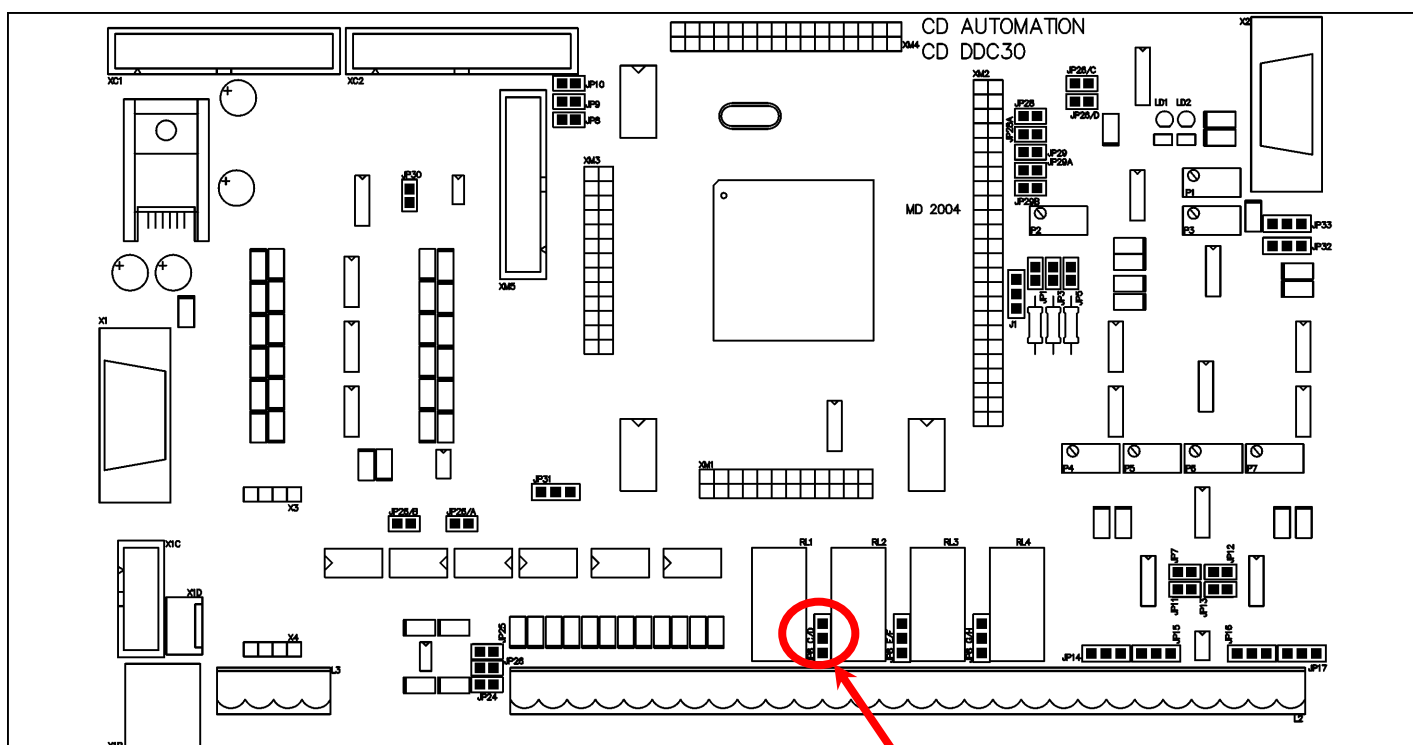

Type	JP8 C/D
NO (standard)	A-B
NC	B-C

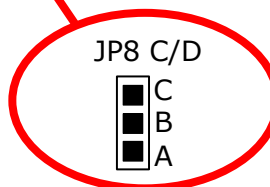

12.7.3 Configurable Digital Output 2 (Terminals 12 and 14 see par. 7.4)

This digital output can be configured in order to activate itself after that one of these alarms occurs:

- SCR in short circuit
- Unbalanced Load
- Heater Break Alarm (HB)
- Current Limit active

The parameter for configurate the output is the P112 *do_2* (see par. 14.2).

The standard contact used for this output is normally open (NO), but is possible change the contact type:



Caution: this procedure must be performed only by qualified persons

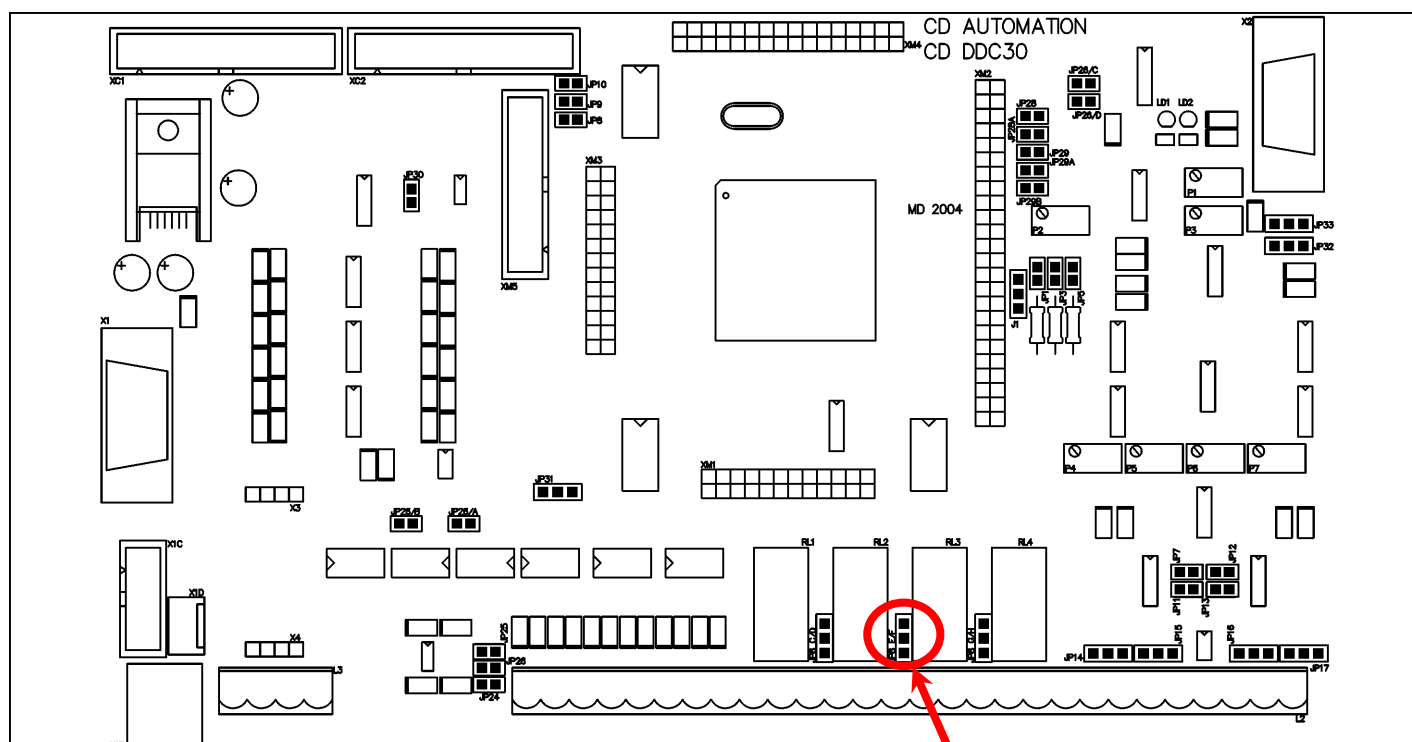

Type	JP8 E/F
NO (standard)	A-B
NC	B-C

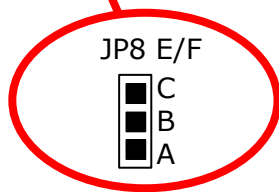

12.7.4 Configurable Digital Output 3 (Terminals 13 and 14 see par. 7.4)

This digital output can be configured in order to activate itself after that one of these alarms occurs :

- SCR in short circuit
- Unbalanced Load
- Heater Break Alarm (HB)
- Low Voltage

The parameter for configurate the output is the P113 *do_3* (see par. 14.2).

The standard contact used for this output is normally open (NO), but is possible change the contact type:



Caution: this procedure must be performed only by qualified persons

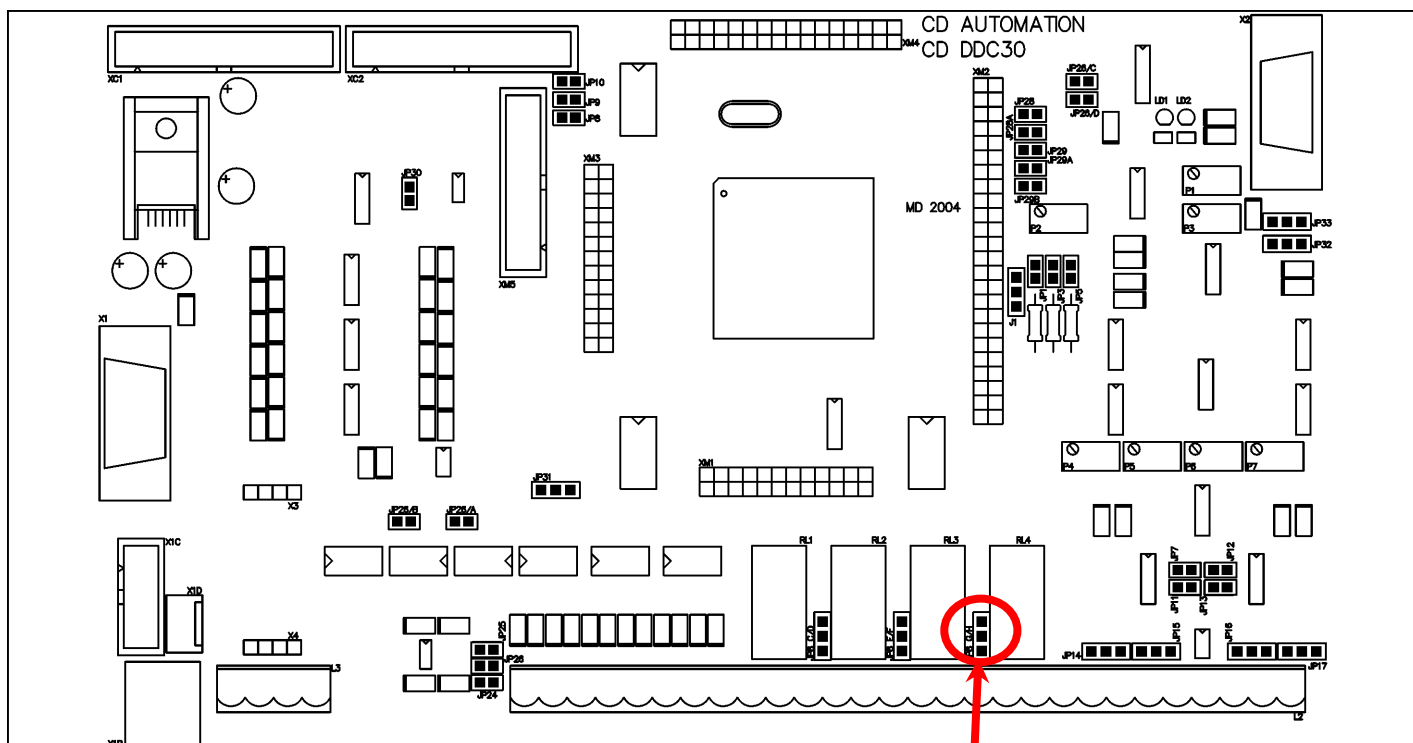

Type	JP8 G/H
NO (standard)	A-B
NC	B-C

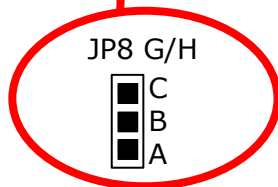

12.8 PG Connector

The PG Connector is used to configure the thyristor unit with the configuration software and with the programming cable.

The programming cable is not included.

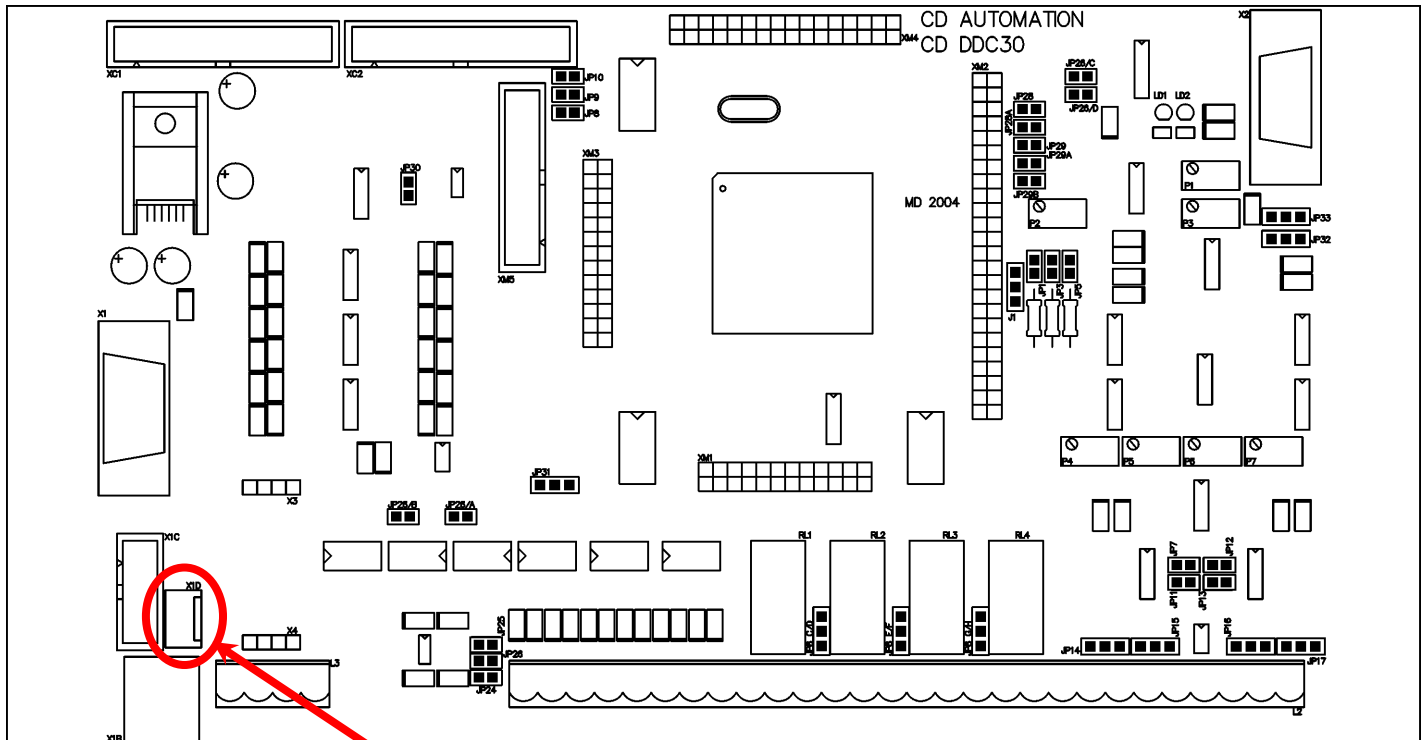

PG Connector

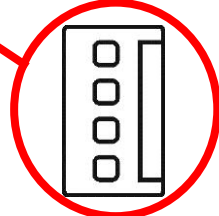

12.9 RS485 Serial Port

The serial communication port RS485 is available on the Command Terminals and on the 9pin DIN male connector.

On this port may be done a network up to 127 MULTIDRIVE.

On the 9pin DIN male connector is also possible connect the CD-EASY (see par. 2.3)

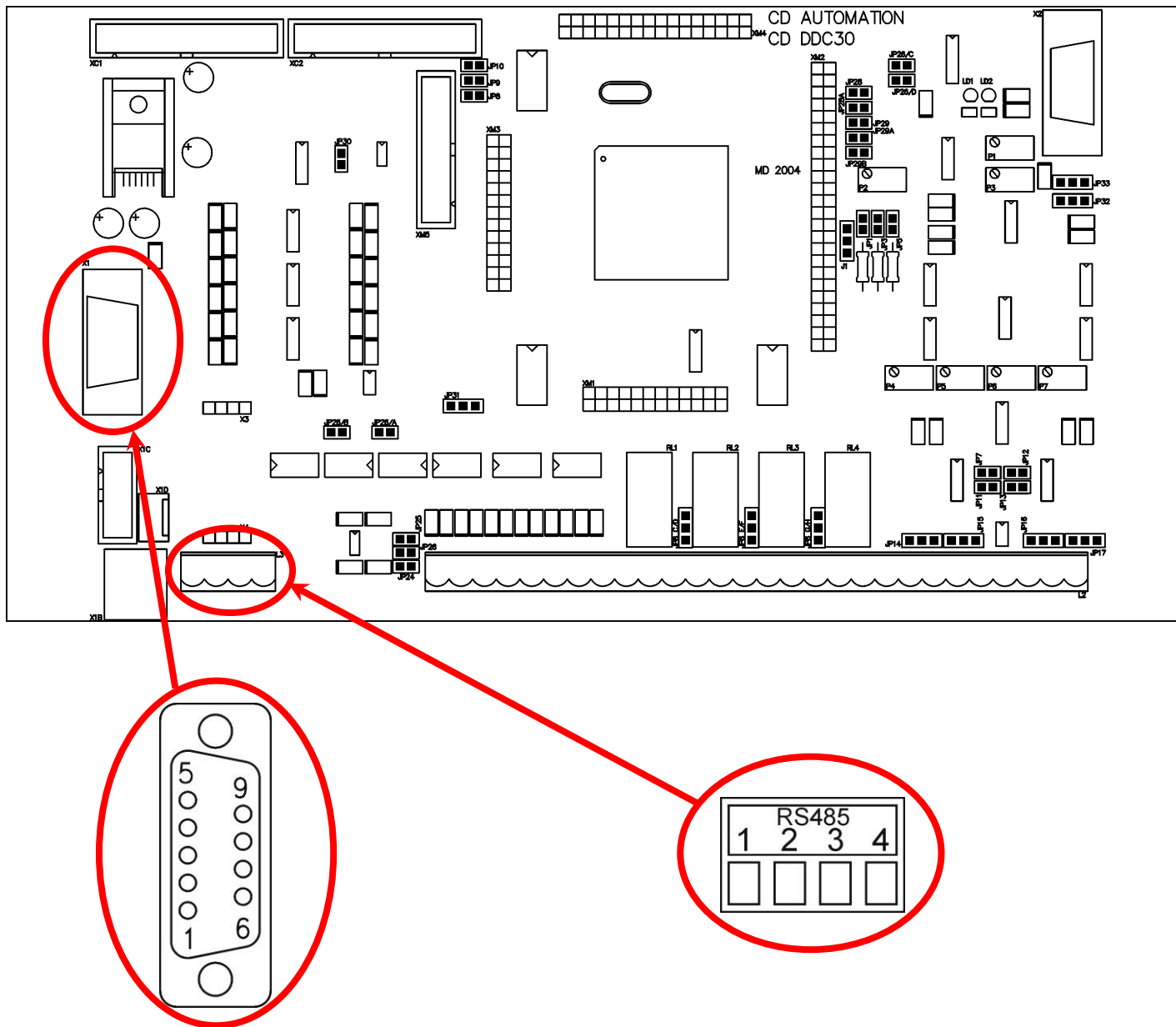

Pin	Description
1	PMS5 (+5V)
2	GND 0V
3	GND 0V
4	Reserved (Rxd0)
5	GND 0V
6	RS485 A
7	RS485 B
8	nc
9	Reserved (Txd0)

Terminal	Description
1	RS485 A
2	RS485 B
3	For internal use
4	For internal use

12.10 Fuse Board protection

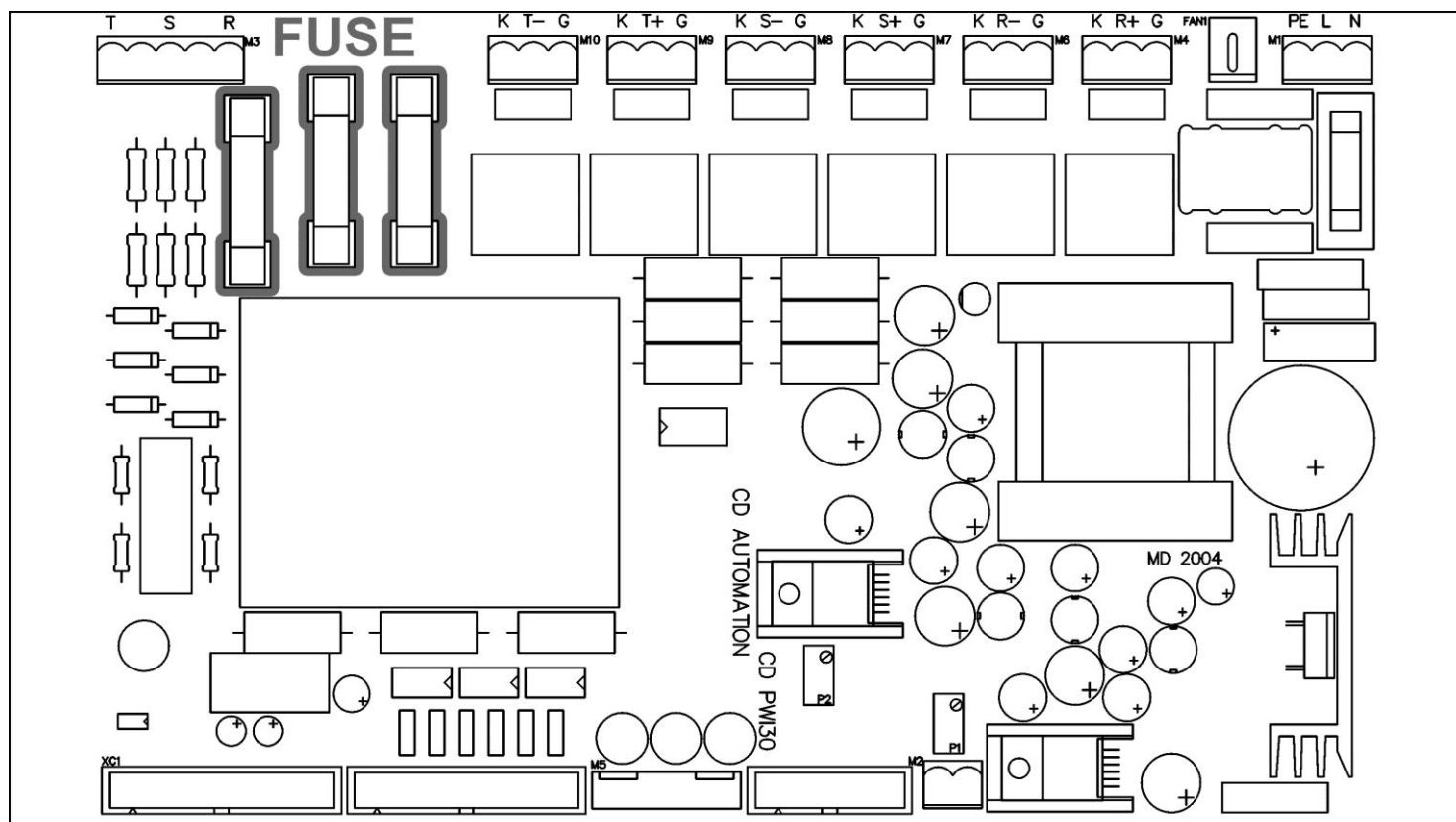

For 690V from 600 to 700A for Canada market the main board is protected with fuses as shown in picture.

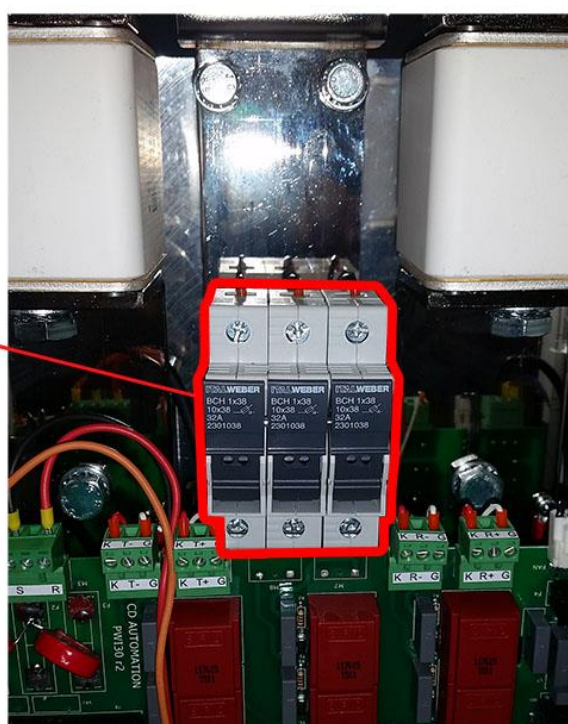

For 690V from 275 to 500A

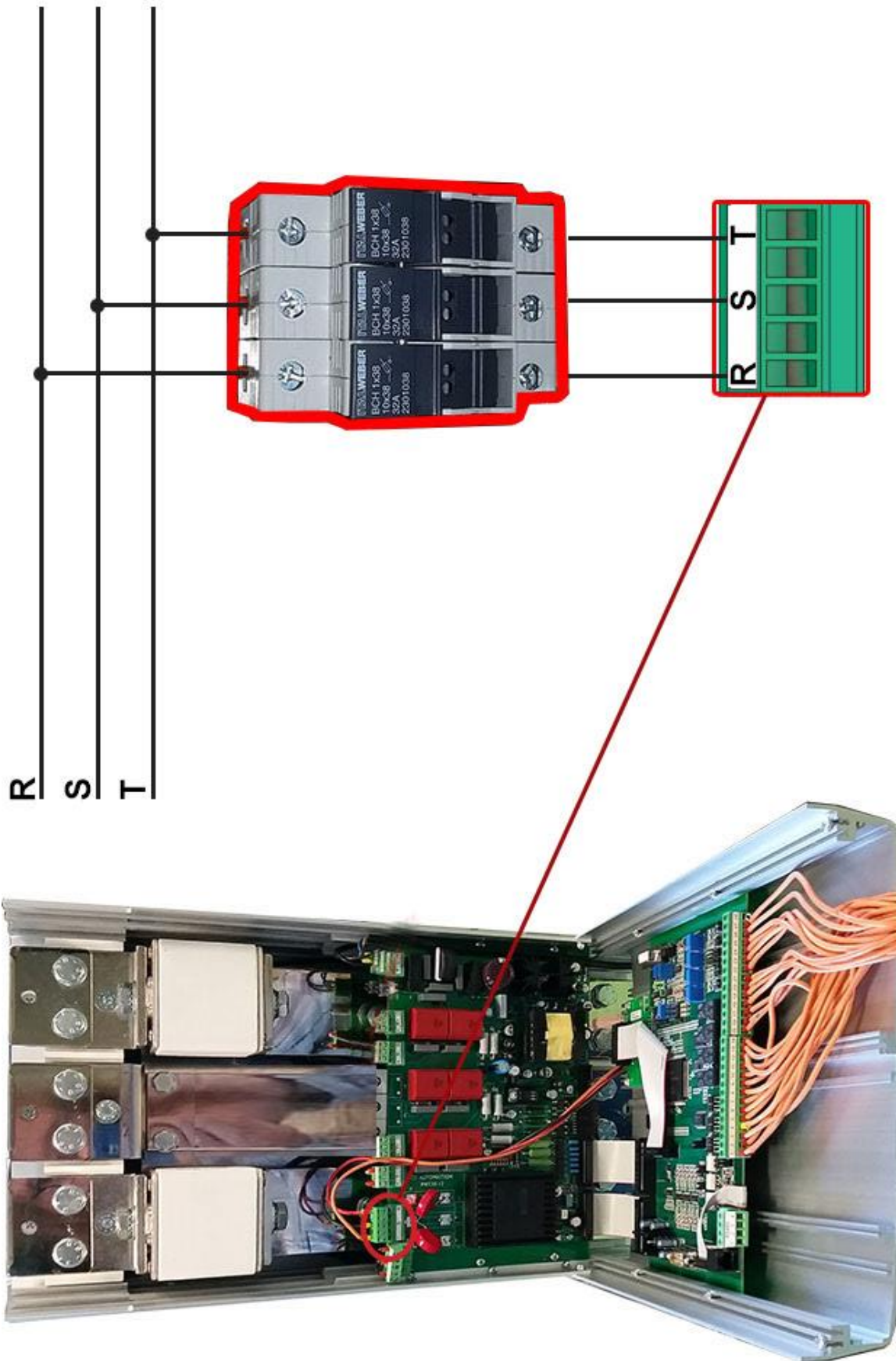

13 MODBUS communication

The serial communication port of the thyristor unit is two-wire RS485 type.

This port use an half-duplex system.

When a Unit must transmit active the transmission line, and when there are not units in transmission the outputs are fixed to high impedance.

The serial communication port allows to communicate between the thyristor units and a MASTER device (ex. an computer or a terminal). The cable must be rated for use to data transfer

13.1 MODBUS RTU Protocol

The communication is based on the standard industrial MODBUS RTU with the following restrictions:



- The Baud rate can be 4800-9600-19200 Baud (Standard 19200).
- The Preset Multiple Registers (Funct. 16) is limited to the writing of a single parameter for message.

The following MODBUS functions are supported:

Function	Description
03	Read Holding Registers
16	Preset Multiple Registers



The unit support the Broadcast messages:

It' possible send a Broadcast messages using the address 0, all the units respond at the message without sending back any reply.

13.2 Message Format

The transmission format is a 1 bit start, 8 date bit, and 1 bit stop with no parity verification.

Each message terminate after a said time of "time out", equal at 3.5 time of a character transmission, where there are not transitions on the transmission line.

The first Byte of each message is always the address of the unit that is a value from 1 to 255 or 0 for the broadcast messages, the second is always the function number, and the rest of the message depends of the function demand.



When a Slave receive an message, the unit send an answer with the same structure but with the information demanded.

Each message is followed by CRC (Cyclic Redundancy Check) with two byte. The CRC identify the incongruity situations of the message, in this case the receiver ignore the message.

The CRC is calculated in accordance with a formula that imply a recursive division of the data by a polynomial.

The polynomial divisor is:

$$2^{16} + 2^{15} + 2^2 + 1 (\text{Hex } 18005)$$

but is modified in two ways:

- Since the bits order are reversed, then the binary pattern is also reversed, and the most significant bit (MSB) is the right-most bit.
- Since interest only the remainder, the right-most bit could be discarded.

Therefore, the polynomial divisor has value: Hex A001

Normal bit order:

Most significant bit																Least significant bit
	Most significant Byte							Least significant Byte								

Reversed bit order:

Least significant bit																Most significant bit
	Least significant Byte							Most significant Byte								

N.B.: With the reversed bit order, also the CRC16 returns the with the reversed bit order



The following flow-diagram show how to organize the CRC 16 bit.

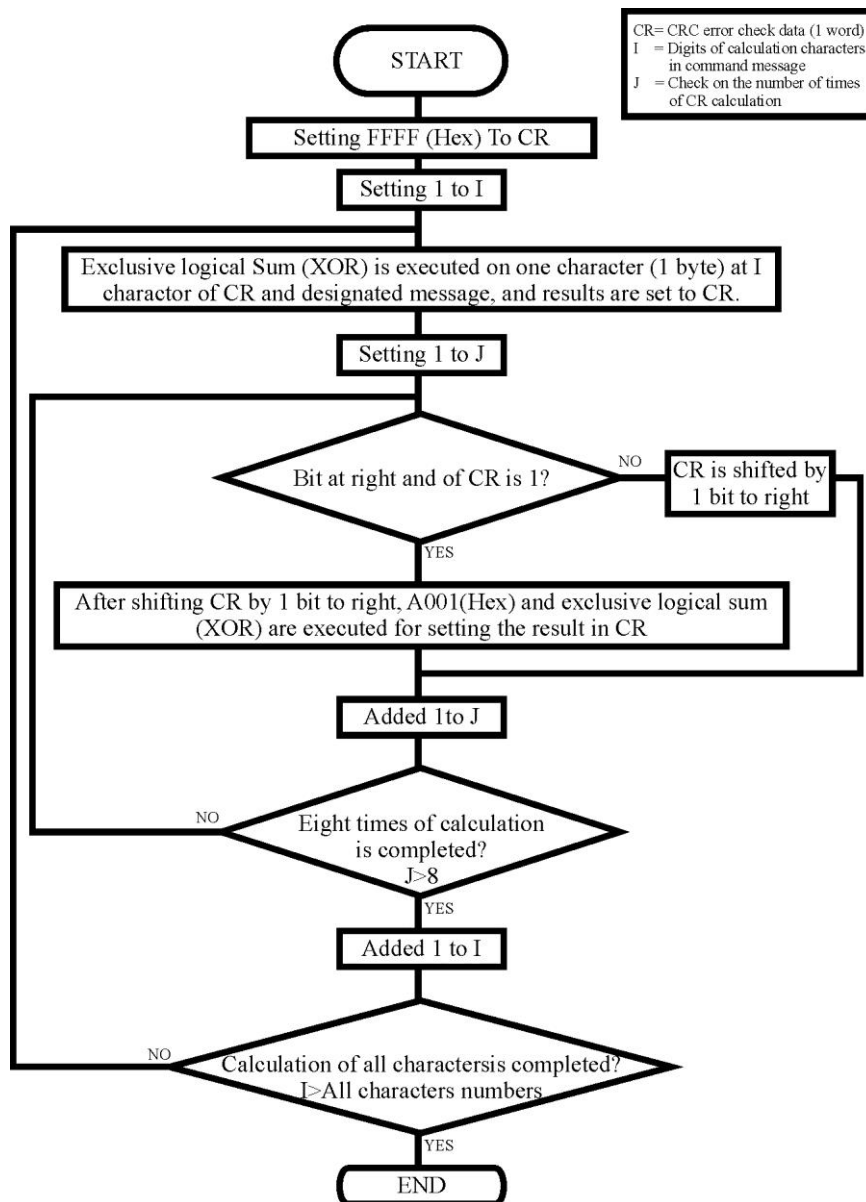

C Language CRC 16 Example

```

static short CRC16 (unsigned char *p_first,unsigned char *p_last)
{
    unsigned int crc=0xffff;
    short j;
    for (;p_first<=p_last;p_first++)
    {
        crc ^= *p_first;
        for(j=8;j>0;j--)
        {
            if(crc & 0x0001)
            {
                crc = crc >> 1;
                crc ^= 0xA001;
            }
            else
            {
                crc = crc >> 1;
            }
        }
    }
    return (crc);
}
  
```

13.3 Read Holding Registers

This function reads the instantaneous value of **only one** specified number of parameter from an address.

The message is composed by 8 Byte: one Byte is for the address, one for the function (03 Hex), two Byte for the first parameter to read, two Byte for the total number of parameters to read that is **fixed to 1 (0001 Hex)**, and finally two Byte for the CRC:

Address Unit	Function	Address of the First Parameter		N° of the Parameter		CRC 16	
		HI	LO	0	1	LO	HI
	3 3Hex						

The answer is an echo of the first two Byte (address and function), one byte with the number of following byte to exclusion of the CRC, the demanded values and finally two Byte for the CRC:

Address Unit	Function	N° of Byte	First Parameter Value		CRC 16	
			HI	LO	LO	HI
	3 3Hex	2				

13.4 Preset Multiple Registers

This function could write only a parameter for each message.

The message is composed by 11 Byte: one Byte for the address, one for the function (10 Hex), two Byte for first parameter to write, two Bytes for the N° of parameters, fixed to 1 (0001 Hex), one Byte with the number of following Bytes, fixed to 2 (02 Hex), two Byte for the CRC:

Address Unit	Function	Address of the First Parameter		N° of the Parameter		N° of Byte	Value to write		CRC 16	
		HI	LO	0	1		2	HI	LO	LO
	16 10Hex									

The answer is an echo of the first two Byte (address and function), two Byte for first written parameter, two Byte with the N° of parameters, fixed to 1 (0001 Hex), two Byte for the CRC:

Address Unit	Function	Address of the First Parameter		N° of the Parameter		CRC 16	
		HI	LO	0	1	LO	HI
	16 10Hex						

13.5 Error and exception responses

If a message contains an altered character, if fails the CRC, or if the received message contains a syntax error (for example the number of the byte or of the words is not correct), then the unit will ignore the message.

If the received message is correct but contains a not valid value, the unit will send an answer of exception (5 byte):

Address Unit	Function	Error Code	CRC 16	
			LO	HI

The byte with the function number, represent the function number of the message that has caused the error with the first Bit set to 1 (ex. the function 3 becomes 0x83) The error code could be one of the followings:

Error Code	Name	Cause
1	ILLEGAL FUNCTION	Function not supported.
2	ILLEGAL DATA ADDRESS	Address out of range.
3	ILLEGAL DATA VALUE	Attempt to write invalid or action not carried out.



NOTE: If you write a parameter's value equal at his actual value this is a valid transaction and don't cause an error.

13.6 Address Configuration

The thyristor unit is assigned a unique device address by the user in the range 1 (default) to 127 using the parameter P115 *Addr* in the Hardware menu. This address is used to recognise the messages queries to her assigned.

The thyristor unit does not respond at the messages queries that don't have the same assigned address.

The thyristor unit will also accept global messages (Broadcast) sends at the address 0. No responses

14 Configuration Parameters

The Configuration Parameters are accessible from the Control Panel (place in front of unit), from the software configurator or through the serial communication port RS485.

With the RS485 Serial Port the parameters are not divided by menu, but only by numerical order.

14.1 Operator Menu

P000 (H00)	<i>PASS</i>	Password		R/W
Function:		This parameter gives access at the available menus.		
Value:		0 = Operator Menu 5 = Setup Menu 10 = Hardware Menu		
Note:		With the RS485 Serial Port this parameter are not used.		
P001 (H01)	<i>AL_1</i>	Code of Critical alarm		R
Function:		This parameter read only gives information on the following alarms that they stop the MULTIDRIVE.		
Valore:		00 = No Alarm 01 = Phase Loss 20 = External Alarm 40 = Heat-sink over temperature		
Note:		If more alarms occur, the value will be equal at the sum of the two alarms. example: External Alarm + Phase Loss= 20 + 01 = 21		
P002 (H02)	<i>AL_2</i>	Code of Not Critical alarm		R
Function:		This parameter read only gives information on the following alarms that don't stop the MULTIDRIVE.		
Value:		00 = No Alarm 01 = Thyristor Failure 02 = Heater Break Alarm 04 = Unbalanced Load		
Note:		If more alarms occur, the value will be equal at the sum of the two alarms. example: Thyristor Failure + Heater Break Alarm = 01 + 02 = 03		
P003 (H03)	<i>L--r</i>	Setpoint selection Analog / Digital		R/W
Function:		This parameter determines the use of the analog setpoint (terminal 17-18) or of the digital setpoint setted in the parameter P004 <i>L_SP</i> .		
Value:		0 = Analog setpoint 1 = Digital setpoint		
Default:		0		
Note:		The parameter is not memorized in EEPROM.		
P004 (H04)	<i>L_SP</i>	Setpoint Digital Value	%	R/W
Function:		This parameter contains the digital setpoint value, active with P003 <i>L--r</i> = 1		
Min/Max:		0 ÷ 100%		
Default:		0		
Note:		The parameter is not memorized in EEPROM.		
P008 (H08)	<i>r_SP</i>	Valore Setpoint Analogico	%	R
Function:		This parameter read only contains the analog setpoint value present at the terminals 17-18 of the command terminals.		
Min/Max:		0 ÷ 100%		
Example:		With input 4÷20mA: Input 4mA P008 <i>r_SP</i> = 0 Input 12mA P008 <i>r_SP</i> = 50 Input 20mA P008 <i>r_SP</i> = 100		

P011 (H0B)	<i>U_Ln</i>	Voltage supply	V	R
Function:		This parameter read only contains the voltage value of the power supply.		
P019 (H13)	<i>Outn</i>	Maximum output	%	R/W
Function:		This parameter set in % the maximum output voltage.		
Min/Max:		0 ÷ 100%		
Default:		100		
P024 (H18)	<i>rP_u</i>	Setpoint Ramp Up	Sec	R/W
Function:		This parameter set the Setpoint Ramp Up.		
Min/Max:		0 ÷ 1000 seconds		
Default:		2		
P025 (H19)	<i>rP_d</i>	Setpoint Ramp Down	Sec	R/W
Function:		This parameter set the Setpoint Ramp Down.		
Min/Max:		0 ÷ 1000 seconds		
Default:		2		
P031 (H1F)	<i>Uout</i>	Average voltage output on the three phases	V	R
Function:		This parameter read only show the Average voltage output on the three phases.		
P032 (H20)	<i>Po</i>	Average power output on the three phases	Kw	R
Function:		This parameter read only show the Average power output on the three phases.		
P033 (H21)	<i>R_r</i>	RMS Current on the phase R	A	R
Function:		This parameter read only shows the RMS current present on the power terminal L1.		
P034 (H22)	<i>R_s</i>	RMS Current on the phase S	A	R
Function:		This parameter read only shows the RMS current present on the power terminal L2.		
P035 (H23)	<i>R_t</i>	RMS Current on the phase T	A	R
Function:		This parameter read only shows the RMS current present on the power terminal L3.		
P116 (H74)	<i>U_OP</i>	Operative Load Voltage	V	R/W
Function:		This parameter is used to set in volt the operative voltage of the load.		
Min/Max:		24 ÷ 1000V		
Default:		400 (if not specified in the Order Code)		
Note:		For voltage under the 330V or upper to 600V its necessary makes hardware modification. For this reason it's very important specify this value in the Order Code.		
P119 (H77)	<i>R_Lo</i>	Load nominal Current	A	R/W
Function:		This parameter is used to set the Load nominal Current.		
Min/Max:		0 ÷ 300.0 Ampere for size from 25 to 300A 0 ÷ 3000 Ampere for size upper to 300A		
Default:		Max Current of MULTIDRIVE (if not specified in the Order Code)		
Example:		Size of MULTIDRIVE (Max Current) : 100A Load nominal Current: 50A P119 <i>R_Lo</i> =50.0		
Note:		This parameter is necessary to have the correct rescaling inside the unit. For this reason it's very important specify this value in the order code.		

14.2 Hardware Menu

P057 (H39)	<i>L A1</i>	Calibration min value of analog input 1	R/W
Function:		This parameter saves in memory the min value of the primary analog input (see par. 12.4.1)	
Value:		0 = Default 1 = Save value	
Note:		The input Calibration procedure is necessary only if you change the input type (ex. from 0÷10V to 4÷20mA) and must be performed only by qualified persons.	
P058 (H3A)	<i>H A1</i>	Calibration max value of analog input 1	R/W
Function:		This parameter saves in memory the max value of the primary analog input (see par. 12.4.1)	
Value:		0 = Default 1 = Save value	
Note:		The input Calibration procedure is necessary only if you change the input type (ex. from 0÷10V to 4÷20mA) and must be performed only by qualified persons.	
P059 (H3B)	<i>L A2</i>	Calibration min value of analog input 2	R/W
Function:		This parameter saves in memory the min value of the secondary analog input (see par. 12.4.2)	
Value:		0 = Default 1 = Save value	
Note:		The input Calibration procedure is necessary only if you change the input type (ex. from 0÷10V to 4÷20mA) and must be performed only by qualified persons.	
P060 (H3C)	<i>H A2</i>	Calibration max value of analog input 2	R/W
Function:		This parameter saves in memory the max value of the secondary analog input (see par. 12.4.2)	
Value:		0 = Default 1 = Save value	
Note:		The input Calibration procedure is necessary only if you change the input type (ex. from 0÷10V to 4÷20mA) and must be performed only by qualified persons.	
P061 (H3D)	<i>L A3</i>	Calibration min value of analog input 3	R/W
Function:		This parameter saves in memory the min value of the External Current Profiler analog input (see par. 12.4.3)	
Value:		0 = Default 1 = Save value	
Default:		0	
Note:		The input Calibration procedure is necessary only if you change the input type (ex. from 0÷10V to 4÷20mA) and must be performed only by qualified persons.	
P062 (H3E)	<i>H A3</i>	Calibration max value of analog input 3	R/W
Function:		This parameter saves in memory the max value of the External Current Profiler analog input (see par. 12.4.3)	
Value:		0 = Default 1 = Save value	
Default:		0	
Note:		The input Calibration procedure is necessary only if you change the input type (ex. from 0÷10V to 4÷20mA) and must be performed only by qualified persons.	
P097 (H61)	<i>o4A</i>	Offset of the Analog Outputs	R/W

Function:	This parameter is used to set the offset for the Analog Outputs.
Value:	0 = 0 ÷ 10Vdc / 0 ÷ 20mA 1 = 4 ÷ 20mA
Default:	0 (if not specified in the Order Code)

P103 (H67)	<i>C_d1</i>	Digital input configuration (terminal 8)	R/W
Function:		This parameter selects the function of digital input.	
Value:		0 = Additional Reset Alarm 1 = Setpoint Zero 2 = Feed-back Selection 3 = Setpoint Analog/Digital 4 = External Alarm	
Default:		1	
P104 (H68)	<i>C_A1</i>	Full scale of Analog Output 1 (Power Average)	Kw R/W
Function:		This parameter is used to adjust the full scale value of the analog output.	
Min/Max:		0 ÷ 300.0 Kw for size from 25 to 300A 0 ÷ 3000 Kw for size upper to 300A	
Default:		1000	
P106 (H6A)	<i>C_A2</i>	Full scale of Analog Output 2 (RMS Current on L1)	A R/W
Function:		This parameter is used to adjust the full scale value of the analog output.	
Min/Max:		0 ÷ 300.0 Ampere for size from 25 to 300A 0 ÷ 3000 Ampere for size upper to 300A	
Default:		1000	
P108 (H6C)	<i>C_A3</i>	Full scale of Analog Output 3 (RMS Current on L2)	A R/W
Function:		This parameter is used to adjust the full scale value of the analog output.	
Min/Max:		0 ÷ 300.0 Ampere for size from 25 to 300A 0 ÷ 3000 Ampere for size upper to 300A	
Default:		1000	
P110 (H6E)	<i>C_A4</i>	Full scale of Analog Output 4 (RMS Current on L3)	A R/W
Function:		This parameter is used to adjust the full scale value of the analog output.	
Min/Max:		0 ÷ 300.0 Ampere for size from 25 to 300A 0 ÷ 3000 Ampere for size upper to 300A	
Default:		1000	
P112 (H70)	<i>do_2</i>	Digital output configuration (terminal 12)	R/W
Function:		This parameter selects the function of the digital output.	
Value:		0 = Thyristor Failure 1 = Heater Break Alarm (HB) 2 = Unbalanced Load 3 = Current limit active	
Default:		1	
P113 (H71)	<i>do_3</i>	Digital output configuration (terminal 13)	R/W
Function:		This parameter selects the function of the digital output.	
Value:		0 = Thyristor Failure 1 = Heater Break Alarm (HB) 2 = Unbalanced Load 3 = Low voltage	
Default:		0	
P114 (H72)	<i>bAud</i>	Baud Rate	R/W
Function:		This parameter selects the Baud rate on the serial port.	
Value:		0 = 4800 1 = 9600 2 = 19200	
Default:		2	
P115 (H73)	<i>Addr</i>	Address	R/W
Function:		This parameter selects the Address on the serial port for the thyristor unit.	
Min/Max:		1 ÷ 127	

Default: 1

14.3 Setup Menu

P023 (H17)	<i>Fir</i>	Firing Type	R/W
Function:		This parameter selects the Firing Type.	
Value:		0= BURST firing mode 2= DELAY TRIGGERING mode	
Default:		0 (if not specified in the Order Code)	
P066 (H42)	<i>Hb_S</i>	HB sensitivity	% R/W
Function:		This parameter defines the threshold of current that activates the HB alarm This value is in percentage respect the nominal load value	
Min/Max:		0,0 ÷ 100,0%	
Default:		100,0	
Example:		Nominal Current 100A P066 <i>Hb_S</i> =20. This means that the Heather Break Alarm became active when the current goes below 80A	
P070 (H46)	<i>FEEd</i>	Feed back selection	R/W
Function:		This parameter selects the Feed-back type.	
Value:		0 = Current feed-back (rms value) 1 = Voltage feed-back (rms value) 2 = Power feed-back VxI 3 = External feed-back	
Default:		1 (if not specified in the Order Code)	
Note:		Feed-back value is the average value on the three phase R, S, T	
P083 (H53)	<i>bF_n</i>	Burst Firing Cycles	Cycles R/W
Function:		It defines the number of voltage cycles in ON condition at 50% of power demand	
Min/Max:		1 ÷ 255 cycles	
Default:		8 (if not specified in the Order Code)	
P085 (H55)	<i>dE</i>	Delay triggering (Not used in others firing)	° R/W
Function:		This parameter set firing delay in °	
Min/Max:		0 ÷ 100°	
Default:		80	
P090 (H5A)	<i>[L_i</i>	Current Limit select Analog/Digital	R/W
Function:		This parameter determines the use of the analog or digital Current Limit	
Value:		0 = Analog, Current Limit from analog input (terminals 21-22) 1 = Digital, Current Limit from parameter P091 <i>[L_i</i>	
Default:		1	
Note:		This parameter is saved in EEPROM	
P091 (H5B)	<i>[L_i</i>	Digital Limit current value	% R/W
Function:		This parameter contains the digital Current Limit value, active with P091 <i>[L_i</i> = 1	
Min/Max:		0,0 ÷ 100,0%	
Default:		100,0	
P098 (H62)	<i>LoAd</i>	Load Type	R/W
Value:		0=star 2=delta	
Default:		0 (if not specified in the Order Code)	

15 Internal Fuse

The MULTIDRIVE thyristor unit have internal fuse extrarapid at low I^2t for the thyristor protection of against the short-circuits.

The fuse must have I^2t lower than the thyristor one (I^2t max)



Caution: USE ONLY EXTRARAPID FUSE WITH APPROPRIATE I^2t

15.1 Fuse Code

600V

Size	200 kARMS Symmetrical A.I.C.				Qty
	Fuse CODE	Current (A RMS)	I^2T (A ² sec)	Vac	
45A (S13)	20 559 20.160	160	15400	660	2
75A (S13)	20 559 20.160	160	15400	660	2
100A (S13)	20 559 20.160	160	15400	660	2
125A (S13)	20 559 20.160	160	15400	660	2
150A (S13)	20 559 20.180	180	20400	660	2
225A (S13)	20 559 20.250	250	44000	660	2
275A (S14)	20 559 20.315	315	77000	660	2
400A (S14)	FU450FMM	450	105000	660	2
450A (S14)	FU550FMM	550	215000	660	2
500A (S14)	FU550FMM	550	215000	660	2
600A (S14)	FU700FMM	700	420000	660	2
700A (S14)	FU700FMM	700	420000	660	2
850A (S15)	2xFU450FMM	2x450	420000	660	2

690V

600A (S14)	FU800SIB SQB3 1250V	800	1070000	1250	2
850A (S14)	FU1100SIB SQB3 1000V	1100	2400000	1000	2



Caution: The Fuses must have I^2t 20% less than thyristor's I^2t .



Caution: High speed fuses are used only for the thyristor protection and can not be used to protect the installation.



Caution: The warranty of thyristor is null if no proper fuses are used. See tab.



Warning: The user installation must be protected by electromagnetic circuit breaker or by fuse isolator.



16 Maintenance

16.1 Fans

The thyristor unit with forced ventilation uses fans that rotate permanently when the unit is supplied. In case of fan failure, the heat-sink can reach high temperature. In this case to give protection to thyristor there is a thermal switch properly setted. The function of this switch is to open the input signal until the heat-sink temperature falls below the setted value. This means that also with input signal in ON condition the unit is switched OFF and the system can not work at full power. For this reason is important to control periodically the fans status checking that are rotating.

16.2 Maintenance

For maintain a correct cooling, the consumer must clean the heat-sink and the protective grate of the fans. The frequency of these operations depends on the atmospheric local pollution. Check also that the screw of the power terminals and earth terminals are shut correctly (see Diagram of control connection).

16.3 Repairing procedure

- Phone to CD Automation.
- Explain to Service Engineer the problem because sometimes it can be solved with a phone call. If this is not possible, ship the unit to CD Automation or to your distributor.
- Write a fault description and give the name of your personnel to which refers.
- Use a rugged packaging to ship the unit.

16.4 Warranty condition

CD Automation gives a 12 months warranty to its products. The warranty is limited to repairing and parts substitution in our factory and does exclude products not properly used and fuses. Warranty does not include products with serial numbers deleted. The faulty product should be shipped to CD Automation at customer's cost and our Service will evaluate if product is under warranty terms. Substituted parts remain of CD Automation property.

